

# ***EV Fast Charger – DC 120-180 kW***

***Models:***

***EVFC120-xxxx***

***EVFC150-xxxx***

***EVFC180-xxxx***

## ***Installation and Operation Manual***



MNL215

**READ THIS MANUAL CAREFULLY**

**SAVE ALL INSTRUCTIONS**

**INSTRUCTIONS IMPORTANTES CONCERNANT LA SÉCURITÉ**

**CONSERVER CES INSTRUCTIONS**

This manual contains important information regarding Power Innovations International products or processes listed on the title page. Please read all instructions carefully before assembling, installing, or operating equipment. Keep this manual handy for easy reference.

This manual may accompany other instructional guides or manuals for standard installation and operations of the supported products. Please contact Power Innovations if you need additional guides or manuals and have not received them.

Product names mentioned herein may be trademarks (™) and/or registered trademarks (®) of their respective companies, which may include Power Innovations International, Inc. (part of LITEON Group), LITEON Technology Corporation, or a third party.

**Copyright © 2024-2025**

Power Innovations International, Inc.; American Fork, UT, USA

*All rights reserved.*

# Contents

---

<b>1— Product Overview .....</b>	<b>1</b>
1.1 Introduction .....	1
1.2 Highlighted Features.....	1
1.3 Charger Features Identified .....	2
1.4 Options Available when placing order .....	3
1.5 Symbols Used in this Manual .....	4
1.6 Acronyms Used in this Manual .....	4
<b>2— Safety and Specifications .....</b>	<b>5</b>
2.1 IMPORTANT SAFETY INSTRUCTIONS – SAVE THESE INSTRUCTIONS .....	5
2.2 Specifications for EV Fast Chargers by Model .....	6
<b>3— Installing EV Fast Charger .....</b>	<b>9</b>
3.1 What’s Provided with each EV Fast Charger Model .....	9
3.2 Additional Tools and Supplies Required.....	9
3.3 Plan and Prepare Installation Site Layout .....	10
3.4 Mount Charger Cabinet onto Concrete Pad or Driveway .....	13
3.5 Install Shelf Controllers, Rectifier Modules, and Inverter Modules.....	18
3.6 Configure Cellular Modem and Registering Charger on Network .....	22
3.7 Configure and Wire AC Input Power .....	23
<b>4— Operating EV Fast Charger.....</b>	<b>30</b>
4.1 Charge an EV using a Single-cable EV Fast Charger Model.....	30
4.2 Charge an EV using a Dual-cable EV Fast Charger Model .....	31
4.3 End a Charging Session .....	32
<b>5— Maintaining EV Fast Charger .....</b>	<b>33</b>
5.1 Restart after Emergency Power Off.....	33
5.2 Replace Surge Modules in Surge Protective Device.....	33
<b>6— Regulatory .....</b>	<b>34</b>
<b>7— Warranty .....</b>	<b>34</b>
<b>8— Contact Information .....</b>	<b>35</b>

*This page left intentionally blank.*

# 1—Product Overview

This section provides a product overview for Power Innovations International’s DC 120-180 kW Fast Chargers, Models EVFC120-xxxx, EVFC150-xxxx, and EVFC180-xxxx.

## 1.1 Introduction

Each of these all-in-one DC electric vehicle (EV) Fast Chargers is a power supply and charging authorization terminal that enables a scalable, continuous charging output in a single footprint. Once installed and operational, a user can plug the EV charging cable into their EV, use an RFID card to tap on, receive authorization by the system, and start a charging session.

Although some assembly is required, these fast chargers ship with all the parts required for installation except the electrical conduit and wires (provided by installer). Hardware is included to help complete mounting the charger on a concrete pad or driveway.

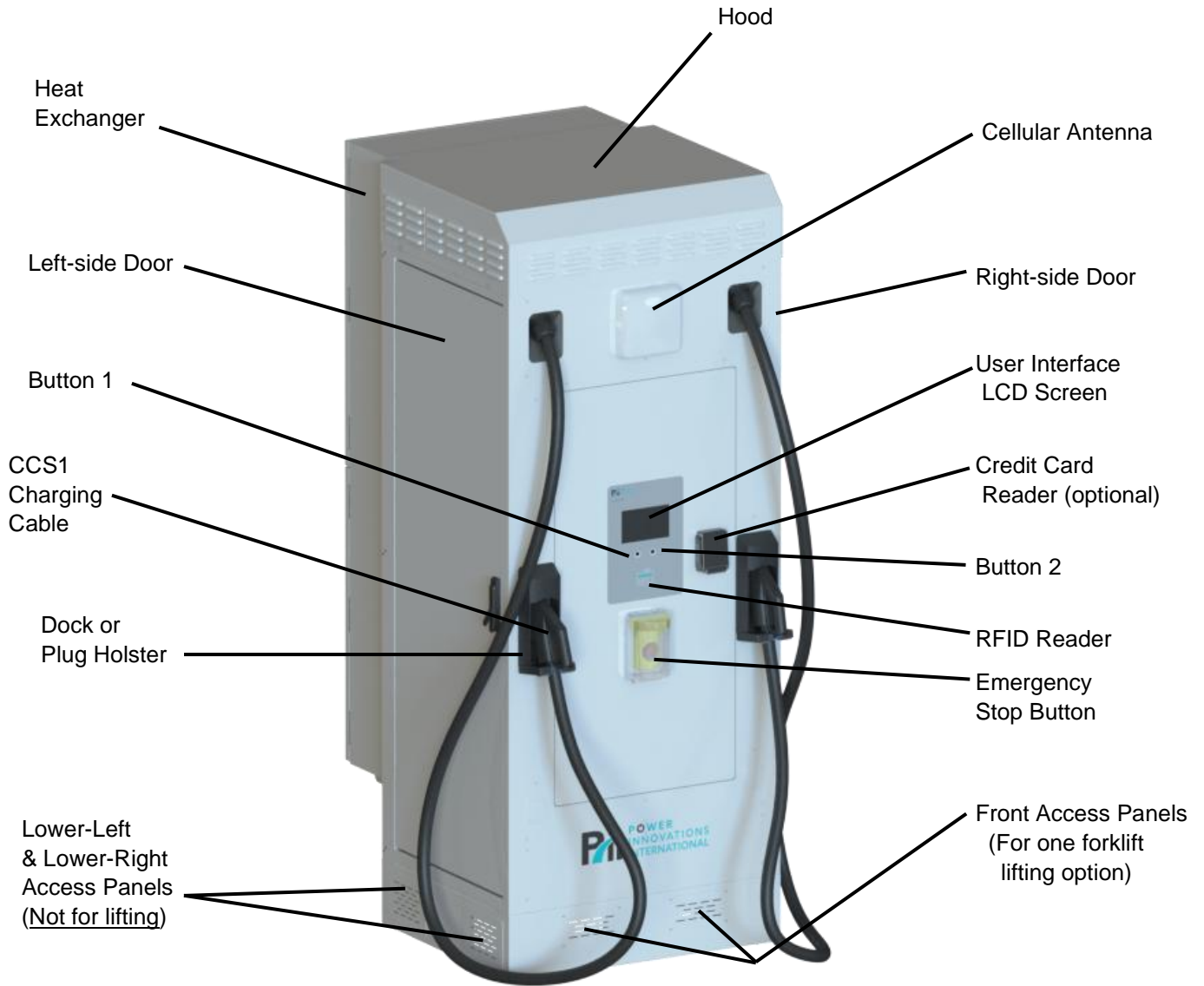
Use this document to help you:

1. Safely prepare installation site
2. Mount fast charger
3. Install power modules and shelf controllers
4. Configure cellular modem and register charger on network
5. Configure and wire AC input power to Fast charger
6. Operate EV Fast charger (Charge an electric vehicle)
7. Maintain EV Fast charger

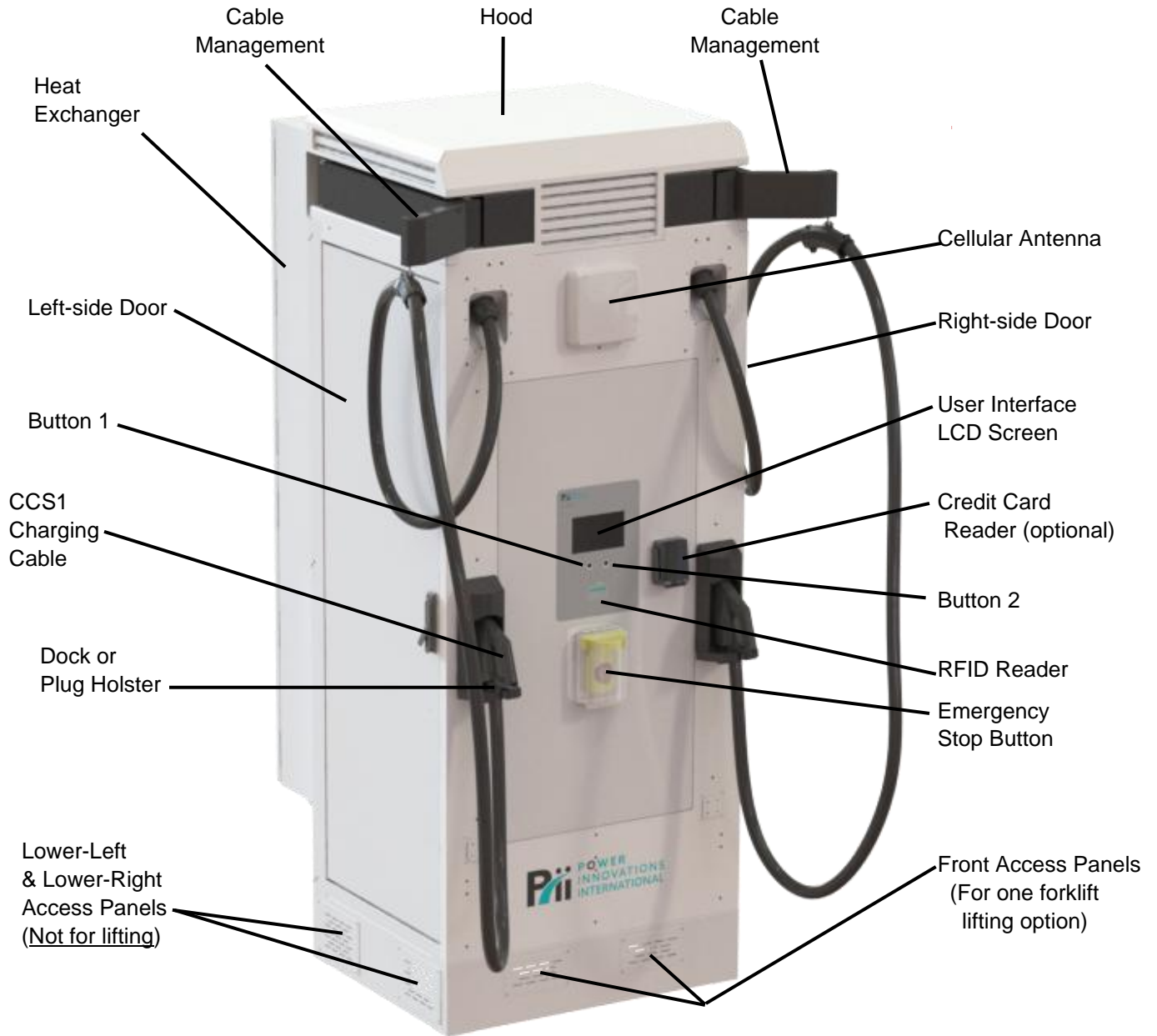
## 1.2 Highlighted Features

Feature	EV Fast Charger
AC Input Power Options	208/240V 3-phase Delta (3-wire + PE) 480V 3-phase Wye (3-wire + Neutral + PE)
Scalable DC Output Power	120 to 180 kW in the same unit
Communication	Cellular 4G LTE Network, Wi-Fi
Multiple payment / authorization methods	RFID Reader Credit Card Reader (optional)
Standard User Interface	Emergency Stop Button LCD Screen RFID Tap payment 2 Buttons

### 1.3 Charger Features Identified



*Figure 1 - EV Fast Charger Model EVFC180-25BS – with Dual 5.5 m charging cable, RFID Reader, and Card Reader*







*Figure 2 - EV Fast Charger Model EVFC180-26BS – with Dual 6 m Charging Cables (with Cable Management), RFID Reader and Card Reader*

## 1.4 Options Available when placing order

- Single or Dual CCS1 charging cables and holsters
- Charging Cable Length: 5.5-meter (standard) or 6-meter (Cable Management)
- Payment Authorization Method: RFID Reader only or Both RFID Reader and Card Reader

## 1.5 Symbols Used in this Manual

Icons or symbols are occasionally used throughout this manual to help identify safety warnings and other pertinent content contained here. These icons are described in the table below.

Icon	Type of Warning	Description
	<b>ELECTRICAL WARNINGS</b>	<b>WARNING! RISK OF ELECTRIC SHOCK!</b> ADDITIONAL TEXT THAT FOLLOWS THIS SYMBOL PROVIDES MORE INFORMATION ABOUT THE SPECIFIC WARNING.
	<b>WARNINGS</b>	<b>WARNING! RISK OF ELECTRIC SHOCK!</b> ADDITIONAL TEXT THAT FOLLOWS THIS SYMBOL PROVIDES MORE INFORMATION ABOUT THE SPECIFIC WARNING.
	<b>CAUTION!</b>	<b>CAUTION!</b> Indicates a potentially hazardous situation which, if not avoided, can result in minor to moderate injury, or serious damage to the equipment. Important safety measures may also be described in Cautions.
	<b>Note</b>	<b>Note</b> Offers practical advice that may be helpful but can be disregarded.

## 1.6 Acronyms Used in this Manual

Acronym	Explanation
AC	Alternating Current
ADA	American Disabilities Act
BABA	Build America, Buy America
DC	Direct Current
EV	Electric Vehicle
NEVI	National Electric Vehicle Infrastructure
Pii	Power Innovations International
PSU	Power Supply Unit
SC	Shelf Controller
SPD	Surge Protective Device



## 2—Safety and Specifications

---

The following safety instructions apply throughout the EV Charger installation process. Be familiar with them before moving on to the next section to complete the installation.

### 2.1 IMPORTANT SAFETY INSTRUCTIONS – SAVE THESE INSTRUCTIONS

#### INSTRUCTIONS IMPORTANTES CONCERNANT LA SÉCURITÉ CONSERVER CES INSTRUCTIONS



#### **ELECTRICAL WARNINGS – WARNING! RISK OF ELECTRIC SHOCK!**

##### **WARNING! RISK OF ELECTRIC SHOCK!**

**ONLY QUALIFIED ELECTRICAL PERSONNEL FAMILIAR WITH THE CONSTRUCTION AND OPERATION OF THIS TYPE OF EQUIPMENT AND THE HAZARDS INVOLVED SHOULD ADJUST, MODIFY, AND SERVICE THIS EQUIPMENT. FAILURE TO OBSERVE THIS PRECAUTION COULD RESULT IN SEVERE INJURY OR DEATH.**

##### **WARNING! RISK OF ELECTRIC SHOCK!**

**READ THIS MANUAL THOROUGHLY PRIOR TO INSTALLING AND ENERGIZING THE EQUIPMENT. INSPECTION AND MAINTENANCE OF THIS EQUIPMENT SHOULD BE PERFORMED IN ACCORDANCE WITH THE PROCEDURES DETAILED IN THIS MANUAL.**

##### **WARNING! RISK OF ELECTRIC SHOCK!**

**THIS UNIT CONTAINS NO INTERIOR PARTS THAT CAN BE SERVICED WITHOUT QUALIFIED PERSONNEL. IF MAINTENANCE PROCESSES SPECIFIED IN THIS MANUAL FAIL TO SOLVE THE PROBLEM, QUALIFIED PERSONNEL MUST SERVICE THE UNIT.**

##### **WARNING! RISK OF ELECTRIC SHOCK!**

**THE PURPOSE OF THIS MANUAL IS TO PROVIDE YOU WITH INFORMATION NECESSARY TO SAFELY INSTALL, OPERATE, AND MAINTAIN THIS EQUIPMENT. KEEP THIS MANUAL FOR FUTURE REFERENCE.**

##### **WARNING! RISK OF ELECTRIC SHOCK!**

**SHUT OFF POWER SUPPLY BEFORE BEGINNING INSTALLATION ACTIVITIES OR MAINTENANCE WORK. FAILURE TO OBSERVE THIS PRECAUTION COULD RESULT IN SEVERE INJURY OR DEATH.**

##### **WARNING! RISK OF ELECTRIC SHOCK!**

**THIS EV FAST CHARGER CONTAINS HIGH VOLTAGE POWER THAT IS POTENTIALLY DANGEROUS IF NOT HANDLED PROPERLY.**



#### **CAUTION!**

**The installer is responsible for conforming to all local and national electrical codes and standards applicable in the jurisdiction this equipment is installed in.**

## 2.2 Specifications for EV Fast Chargers by Model

**Table 1 –Specifications: DC 120 kW Charger EVFC120**

<b>Electrical Specifications</b>	
<b>AC Input</b>	
AC Input Power Options	208 V / 240 V 3-phase Delta (3-wire + PE) 480 V 3-phase Wye (3-wire + Neutral + PE)
AC Input Voltage Operating Range and Current	208V/240V 3-phase Delta: 190V to 252V, 400A max, 50-60 Hz 480V 3-phase Wye: 432V to 504V, 175A max, 50-60 Hz
Recommended minimum upstream overcurrent protection device rating	208V/240V 3-phase Delta: 500A 480V 3-phase Wye: 225A
Power factor	> 0.98
Efficiency	> 95% @ full load
<b>DC Output</b>	
Maximum DC Output Power	120 kW
DC Output Voltage Range	250V – 920V
Maximum DC Output Current for EVFC120	With DC output < 450V = 300A With DC output > 450V = 150A
DC Connector	Single or Dual CCS1
DC Charging Cable Length	5.5 m (18.4 ft.) Standard 6.0 m (19.6 ft.) When using Cable Management
<b>Dimensions and Weights</b>	
EV Charger Dimensions (H x W x D)	H x W x D: 88.8 x 37.2 x 43.8 in. (2257 x 946 x 1113 mm)
Ground Footprint Dimension (W x D)	W x D: 35.4 x 28.7 in. (900 x 730 mm)
Ground Drill-hole Pattern, Outer Holes	W x D: 32.3 x 25.2 in. (820 x 640 mm)
Weight – EV Fast Charger EVFC120	Pre-install 1466 lbs. (665 kg); Fully Loaded 1676 lbs.(760.2 kg)
<b>Communication</b>	
Network Interface and Display	Cellular 4G LTE, WiFi and 7-inch color LCD screen
RFID Payment / Authorization	ISO/IEC 14443 A/B ISO 15393, NFC Reader Mode
<b>Environment Specification</b>	
Operating Temperature Range	-30°C to +50°C
Storage Temperature Range	-40°C to +80°C
Ingression Protection of Enclosure	IP54, NEMA 3R
Humidity	Up to 95% non-condensing
Altitude - Operation	2000 m (6560 ft.)
<b>Certificate/Compliance</b>	
Complies with UL and CSA Standards for Safety	Pending

**Table 2 – Specifications: DC 150 kW Charger EVFC150**

<b>Electrical Specifications</b>	
<b>AC Input</b>	
AC Input Power Options	208 V / 240 V 3-phase Delta (3-wire + PE) 480 V 3-phase Wye (3-wire + Neutral + PE)
AC Input Voltage Operating Range and Current	208V/240V 3-phase Delta: 190V to 252V, 495A max, 50-60 Hz 480V 3-phase Wye: 432V to 504V, 215A max, 50-60 Hz
Recommended minimum upstream overcurrent protection device rating	208V/240V 3-phase Delta: 700A 480V 3-phase Wye: 300A
Power factor	> 0.98
Efficiency	> 95% @ full load
<b>DC Output</b>	
Maximum DC Output Power	150 kW
DC Output Voltage Range	250V – 920V
Maximum DC Output Current for EVFC150	With DC output < 450V = 350A With DC output > 450V = 175A
DC Connector	Single or Dual CCS1
DC Charging Cable Length	5.5 m (18.4 ft.) Standard 6.0 m (19.6 ft.) When using Cable Management
<b>Dimensions and Weights</b>	
EV Charger Dimensions (H x W x D)	H x W x D: 88.8 x 37.2 x 43.8 in. (2257 x 946 x 1113 mm)
Ground Footprint Dimension (W x D)	W x D: 35.4 x 28.7 in. (900 x 730 mm)
Ground Drill-hole Pattern, Outer Holes	W x D: 32.3 x 25.2 in. (820 x 640 mm)
Weight – EV Fast Charger EVFC150	Pre-install 1559 lbs. (707 kg); Fully Loaded 1822 lbs.(826.2 kg)
<b>Communication</b>	
Network Interface and Display	Cellular 4G LTE, WiFi and 7-inch color LCD screen
RFID Payment / Authorization	ISO/IEC 14443 A/B ISO 15393, NFC Reader Mode
<b>Environment Specification</b>	
Operating Temperature Range	-30°C to +50°C
Storage Temperature Range	-40°C to +80°C
Ingression Protection of Enclosure	IP54, NEMA 3R
Humidity	Up to 95% non-condensing
Altitude - Operation	2000 m (6560 ft.)
<b>Certificate/Compliance</b>	
Complies with UL and CSA Standards for Safety	Pending

**Table 3 – Specifications: DC 180 kW Charger EVFC180**

<b>Electrical Specifications</b>	
<b>AC Input</b>	
AC Input Power Options	208 V / 240 V 3-phase Delta (3-wire + PE) 480 V 3-phase Wye (3-wire + Neutral + PE)
AC Input Voltage Operating Range and Current	208V/240V 3-phase Delta: 190V to 252V, 585A max, 50-60 Hz 480V 3-phase Wye: 432V to 504V, 255A max, 50-60 Hz
Recommended minimum upstream overcurrent protection device rating	208V/240V 3-phase Delta: 800A 480V 3-phase Wye: 350A
Power factor	> 0.98
Efficiency	> 95% @ full load
<b>DC Output</b>	
Maximum DC Output Power	180 kW
DC Output Voltage Range	250V – 920V
Maximum DC Output Current for EVFC180	With DC output < 450V = 400A With DC output > 450V = 200A
DC Connector	Single or Dual CCS1
DC Charging Cable Length	5.5 m (18.4 ft.) Standard 6.0 m (19.6 ft.) When using Cable Management
<b>Dimensions and Weights</b>	
EV Charger Dimensions (H x W x D)	H x W x D: 88.8 x 37.2 x 43.8 in. (2257 x 946 x 1113 mm)
Ground Footprint Dimension (W x D)	W x D: 35.4 x 28.7 in. (900 x 730 mm)
Ground Drill-hole Pattern, Outer Holes	W x D: 32.3 x 25.2 in. (820 x 640 mm)
Weight – EV Fast Charger EVFC180	Pre-install 1559 lbs. (707 kg); Fully Loaded 1874 lbs.(850 kg)
<b>Communication</b>	
Network Interface and Display	Cellular 4G LTE, WiFi and 7-inch color LCD screen
RFID Payment / Authorization	ISO/IEC 14443 A/B ISO 15393, NFC Reader Mode
<b>Environment Specification</b>	
Operating Temperature Range	-30°C to +50°C
Storage Temperature Range	-40°C to +80°C
Ingression Protection of Enclosure	IP54, NEMA 3R
Humidity	Up to 95% non-condensing
Altitude - Operation	2000 m (6560 ft.)
<b>Certificate/Compliance</b>	
Complies with UL and CSA Standards for Safety	Pending

## 3—Installing EV Fast Charger



### ELECTRICAL WARNINGS – WARNING! RISK OF ELECTRIC SHOCK!

**WARNING! RISK OF ELECTRIC SHOCK! SHUT OFF POWER SUPPLY BEFORE BEGINNING INSTALLATION ACTIVITIES AND BEFORE REMOVING EV FAST CHARGER’S AC SERVICE PANEL FOR ANY INSTALLATION OR MAINTENANCE WORK. FAILURE TO OBSERVE THIS PRECAUTION COULD RESULT IN SEVERE INJURY OR DEATH.**

**WARNING! RISK OF ELECTRIC SHOCK! ONLY QUALIFIED ELECTRICAL PERSONNEL FAMILIAR WITH THE CONSTRUCTION AND OPERATION OF THIS TYPE OF EQUIPMENT AND THE HAZARDS INVOLVED SHOULD ADJUST, MODIFY, AND SERVICE THIS EQUIPMENT. FAILURE TO OBSERVE THIS PRECAUTION COULD RESULT IN SEVERE INJURY OR DEATH.**

**WARNING! RISK OF ELECTRIC SHOCK! DO NOT CONNECT POWER SUPPLY TO THE EV FAST CHARGER UNTIL THE WIRING AND BUS BAR CONFIGURATION IS COMPLETE AND THE AC SERVICE PANEL IS IN PLACE AND SECURE.**

### 3.1 What’s Provided with each EV Fast Charger Model

120 kW qty.	150 kW qty.	180 kW qty.	Component(s) Included
1	1	1	EV Fast Charger for DC 120 or 180 kW max. output, fully assembled exterior
14	17	20	Shelf Controllers (SCs)
39	48	57	3.3kW Rectifier Modules (also known as Power Supply Units or PSUs)
3	3	3	3.3kW Inverter Modules (for on-board HVAC heat exchanger)
2	2	2	Configuration Bus Bars: 208V/240V Delta or 480V Wye
4	4	4	Eye Bolts, threaded
8	8	8	Wedge Anchors, ½ in. x 3 ¾ in.
4	4	4	Plastic Phase Barriers (for AC Input Panel)
3	3	3	Copper Extensions with ½ in. nuts and washers (for use with Chair/Box Lugs [not provided])
1	1	1	Manual MNL215, “EV Fast Charger – DC 120-180 kW, Models: EVFC120-xxxx, EVFC150-xxxx, EVFC180-xxxx Installation and Operation Manual” (this document)

### 3.2 Additional Tools and Supplies Required

- Level
- Pencil or Marker
- Tape measure
- Electrical Conduit and Wires
- Hand Drill
- (Optional) Cable Gland, sized appropriately for AC input cable
- (Conditional on AC Input Wiring) Set of 3:
  - Suitable Chair/Box Lugs
  - ½ inch Bolt
- T27 Torx driver
- Metric Allen wrench set
- Duct Seal (Recommended)
- Silicon Caulk

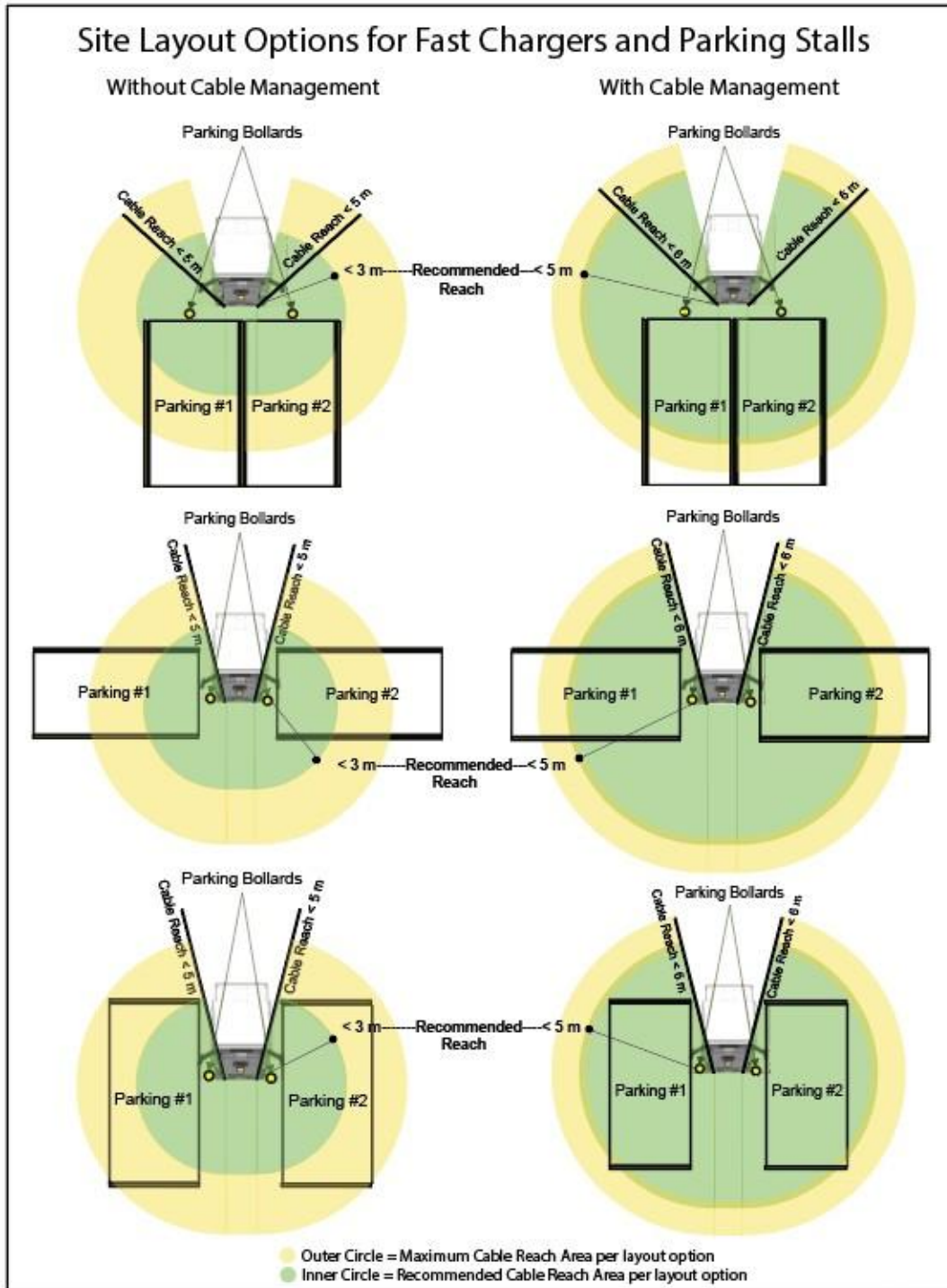
### 3.3 Plan and Prepare Installation Site Layout

1. Do not install or plan to install the fast charger in a hazardous location.



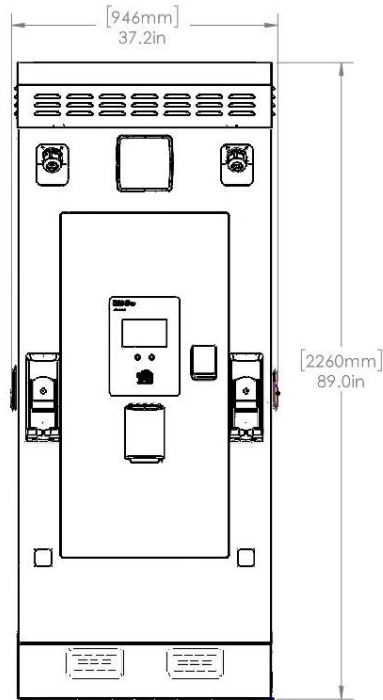
**ELECTRICAL WARNING – WARNING! RISK OF ELECTRIC SHOCK! DO NOT INSTALL OR PLAN TO INSTALL CHARGER IN A HAZARDOUS LOCATION.**

2. Become familiar with the charger’s recommended (green) cable reach areas shown in Figure 3 for charger models without and with cable management, then select the parking stall layout needed for this installation.

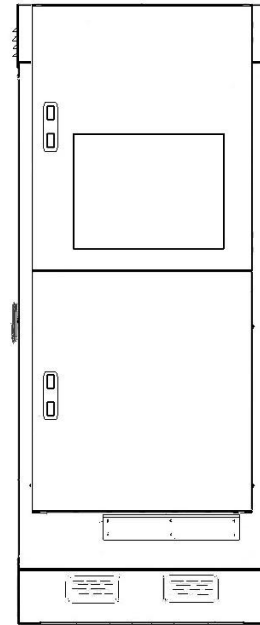


**Figure 3 – Layout options for Fast Charger’s Parking Stalls showing Cable Reach areas**

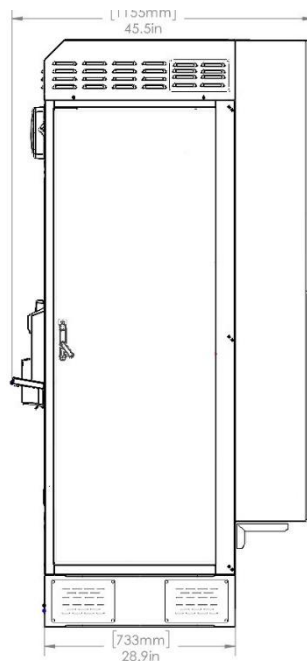
3. Become familiar with essential dimensions of EV Fast Charger Models EVFC120-xxxx, EVFC150-xxxx, and EVFC180-xxxx as shown in Figure 4.1, 4.2, 4.3, and 4.4.



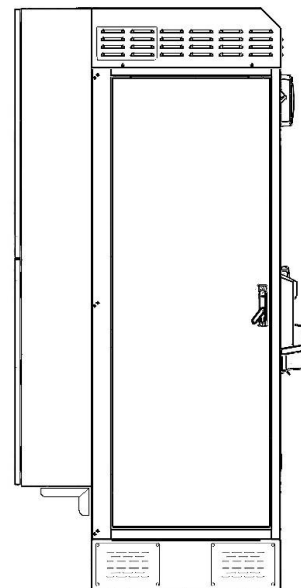
**Figure 4.1 - Front View with Height and Width of 120kW Charger**



**Figure 4.2 - Back View of 120kW Charger with doors to cooler**



**Figure 4.3 - Right Side, Depth of 120kW Charger**



**Figure 4.4 - Left Side of 120kW Charger**

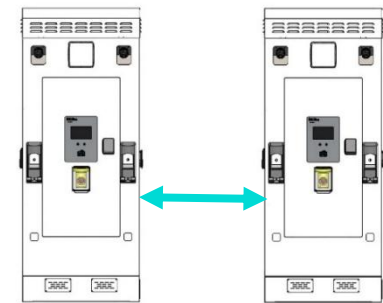
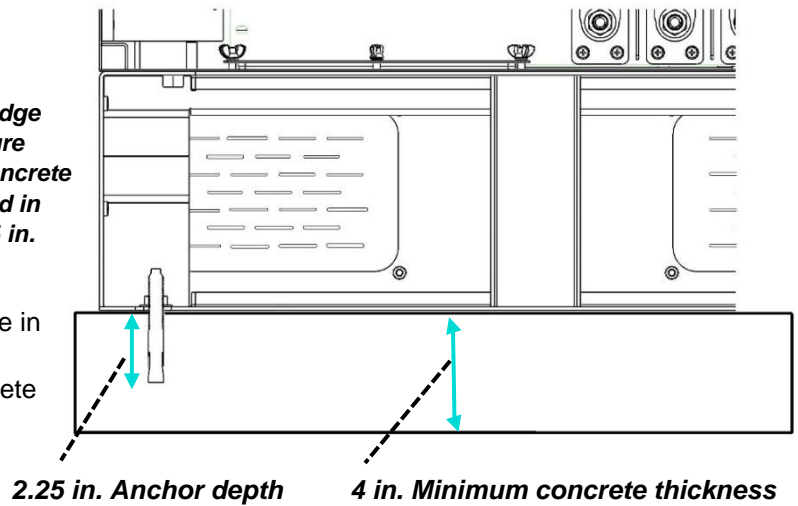
4. Complete the layout plan that adheres to the following list:

**NOTE**  
 Note: The following are suggested practices only. Refer to the local codes for site preparations and installation.

Best Practices for Installation Site

- (a) Select location where charger will not be in direct sunlight.
- (b) Charger should be mounted on a concrete pad or driveway that is 4 inches thick or thicker. The wedge anchors will secure the charger to the concrete when the anchors are installed to a depth of 2.25 inches (7.2 mm) and secured. (Figure 5).
- (c) When laying out placement of 2 or more chargers, ensure the minimum space between chargers will be 1067 mm (42 inches) to help ensure proper user accessibility around each charger (Figure 6).
- (d) When laying out placement of each charger, ensure the back of the charger will be at least 915 mm (36 inches) away from any wall or other structure to allow heat exchanger to function as designed.

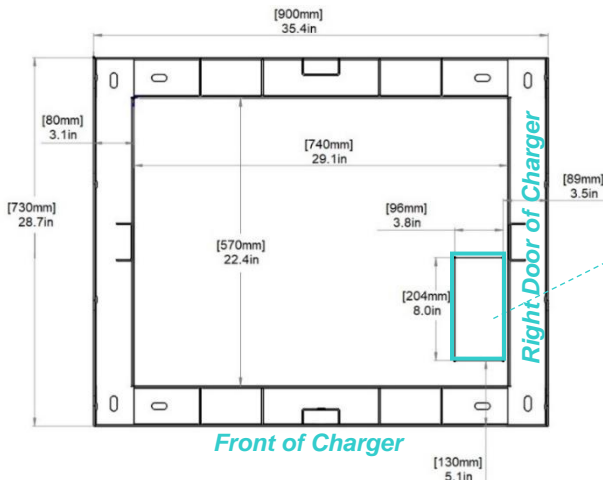
**Figure 5 - Wedge anchors secure charger to concrete when installed in concrete 2.25 in.**



**Figure 6 – Minimum space between chargers is 42 inches (1067 mm)**

- 5. Pre-mark concrete for charger placement using measurements provided in Figure 7. Be sure to include at least the outer footprint, inner footprint, and teal rectangle area. The teal rectangle shows recommended area for AC power-in conduit/cable to emerge from concrete. Anywhere inside charger's inner footprint is acceptable if the conduit is close to ground level and cable is long enough to be re-routed to the charger's right-front corner. But the teal rectangle area has the large opening left by the removeable plate.

Outer Footprint Dimensions = 35.4 x 28.7 inch (900 x 730 mm)  
 Inner Footprint Dimensions = 29.1 x 22.4 inch (740 x 570 mm)



Recommended area inside charger's mounting footprint for AC power-in conduit/cable to emerge from concrete

**Figure 7 - Dimensions of charger footprint, drill hole patterns for wedge anchors, and recommended AC power-in conduit/cable area**



### 3.4 Mount Charger Cabinet onto Concrete Pad or Driveway



**ELECTRICAL WARNINGS – WARNING! RISK OF ELECTRIC SHOCK!**

**WARNING! RISK OF ELECTRIC SHOCK! SHUT OFF POWER SUPPLY BEFORE BEGINNING INSTALLATION ACTIVITIES AND BEFORE REMOVING EV FAST CHARGER’S AC SERVICE PANEL FOR ANY INSTALLATION ACTIVITY. FAILURE TO OBSERVE THIS PRECAUTION COULD RESULT IN SEVERE INJURY OR DEATH.**

**WARNING! RISK OF ELECTRIC SHOCK! DO NOT PROVIDE LIVE POWER TO THE EV FAST CHARGER UNTIL THE WIRING AND BUS BAR CONFIGURATION IS COMPLETE AND THE AC SERVICE PANEL IS IN PLACE AND SECURE.**



**CAUTION!** - This EV Fast charger weighs at least 1466 lbs. (665 kg) before installation and 1676 lbs. (760.2 kg) after fully loading with power supply units (PSUs) and shelf controllers (SCs). To help avoid injury, use a crane or forklift, eye bolts and straps, AND lifting partners when lifting and moving charger onto wedge anchors.

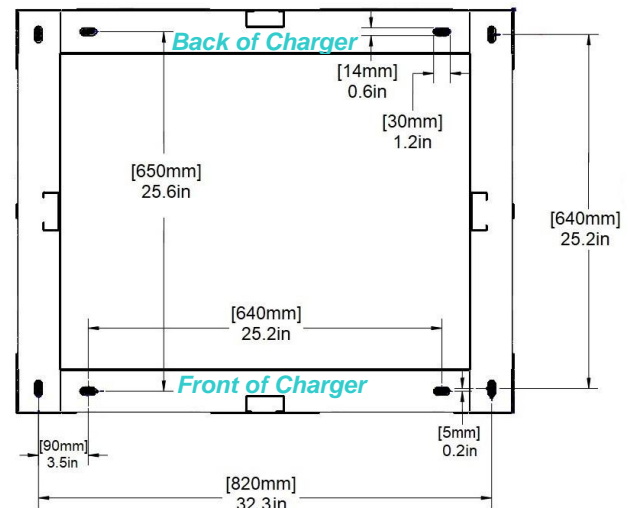


**CAUTION!** - Do not attempt to put forklift forks in any of the side panel openings or back panel openings at the bottom of the charger (see red X’s in Figures 14-15). The forklift forks should only be inserted into the 2 open front panels of the charger to avoid damaging the charger.

1. Ensure AC power-in to EV Fast charger installation location is turned OFF at site’s upstream AC breaker.
2. Route AC power-in conduit / cable up through concrete pad or driveway within pre-marked rectangles of charger’s footprint (Figure 8), leaving sufficient cable length to route cable up front-right corner of mounted charger.



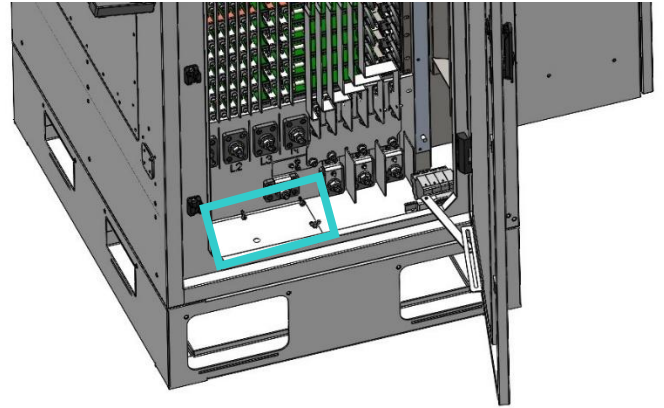
**Figure 8 - AC power-in cables routed out of concrete within charger’s footprint marks on ground**



**Figure 9- Dimensions for Drill hole patterns (8 drill holes darkened)**

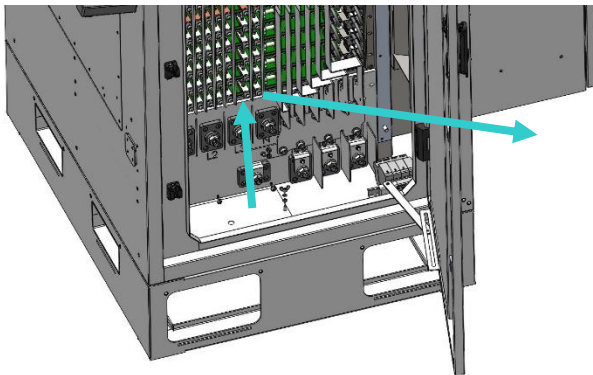
3. (Recommended) Add Duct Seal around opening of conduit/cable coming out of the concrete.
  4. If you don’t have access to a fast charger mounting template:
    - EITHER** - Skip to Step 5 now and wait until prompted in Steps 11-16 to: (1) use the charger itself as a template for marking drill holes on the concrete, (2) move the charger and drill the holes, and then (3) install the wedge anchors.
    - OR** - Complete Steps 4.1 - 4.3 now to: (1) use a tape measure and mark the drill hole patterns on the concrete, (2) drill the holes, and (3) install wedge anchors.
- 4.1 Mark the drill hole patterns (black ovals shown in Figure 9) summarized here:
    - Inner 4 mounting hole pattern: 25.2 x 25.6 inch (640 x 650 mm);
    - Outer 4 mounting hole pattern: 32.3 x 25.2 inch (820 x 640 mm);
    - Notice Center offsets between two sets of holes:
      - Outer hole center is 3.5 in. (90 mm) from nearest Inner hole center.
      - Each Outer hole center is 0.2 in. (5 mm) closer to center of charger depth than nearest Inner hole center.
  - 4.2 Drill the 8 holes in concrete needed for 8 wedge anchors using a 12 mm (1/2 in.) diameter drill bit.
  - 4.3 Remove washer and nut from wedge anchors and hammer all 8 wedge anchors into pre-drilled holes.

5. Open charger's right-side door and then locate the removable plate secured with wingnuts and washers to the floor of the charger (Figure 10).

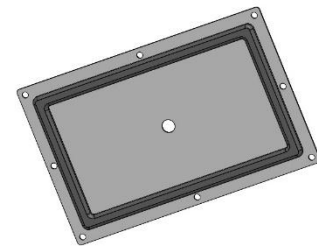


**Figure 10 – Charger's right-side door opened shows removable metal plate on charger floor**

6. Remove all 8 sets of M5 wingnut, split washer, and flat washer that secure the removable plate to the charger floor (Figure 11); then remove the plate, taking care not to damage gasket attached to down-side of plate (Figure 12), and set the plate and hardware aside until after charger is moved to and anchored to concrete and pilot hole in plate is later enlarged.

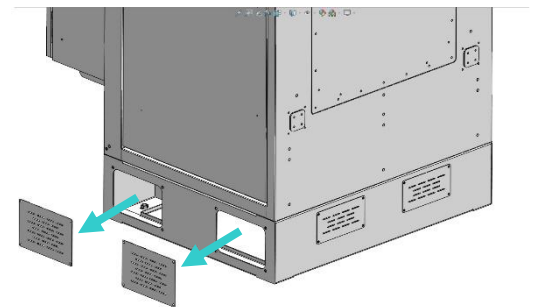


**Figure 11 - Removable plate inside right door of charger is removed before moving charger onto concrete with conduit**



**Figure 12 - Down-side of Removable Plate**

7. Disconnect the charger from its pallet:
  - a. Using a T27 Torx driver, remove lower access panels on the left and right sides to reach the 4 inside corners of the charger (Figure 13).
  - b. Reach into opened lower access panels and remove the 4 hex bolts and washers securing the charger to the pallet (also see Figure 13).



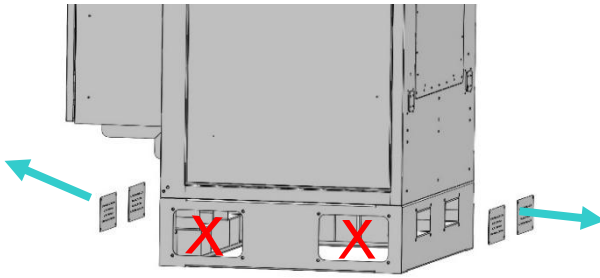
**Figure 13 - Removing left and right access panels to access 4 hex bolts and washers securing charger to pallet**

8. Prepare the charger to be moved by a forklift using one of the two supported methods:

One way to move the charger by a forklift is to remove the front and back panels at the bottom of the charger (Figure 13), insert the forks through the front openings (Figure 14) towards the back openings, and then lift and move the charger. If you plan to use the forklift openings, remove the 2 front panels and the 2 back panels now and skip to Step 10.

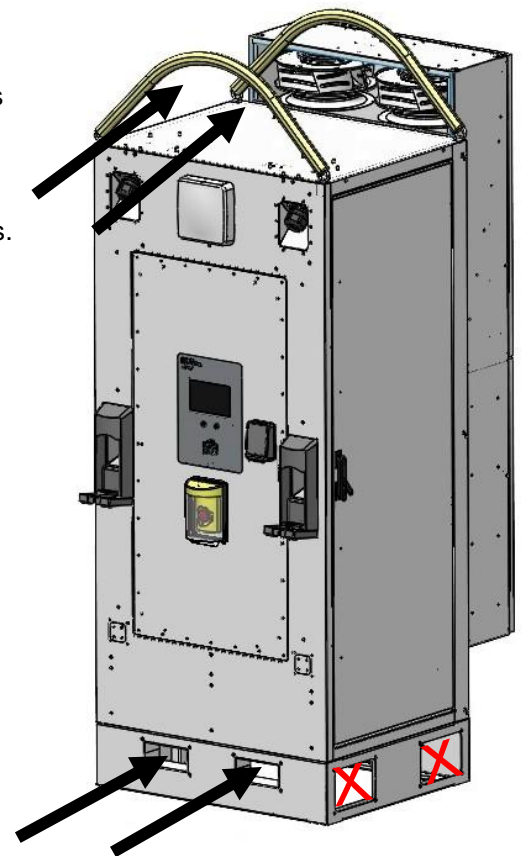


**CAUTION!** Do not attempt to put forklift forks in any of the side panel openings (Red Xs in Figure 14 and Figure 15) or in the open back panels at the bottom of the charger. The forklift forks should only be inserted into the 2 open front panels of the charger to avoid damaging the charger.



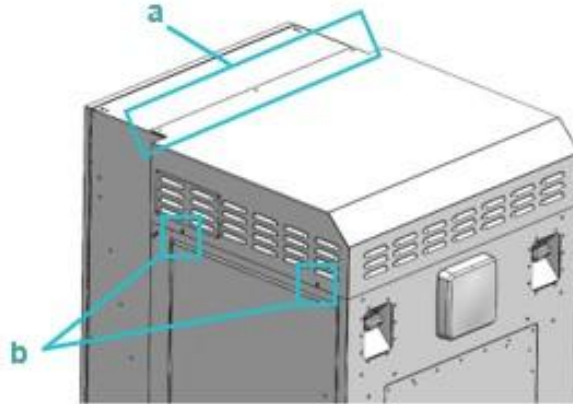
*Figure 14 - Removing front and back access panels to prepare for forklift to lift off pallet*

Another supported way to move the charger using a forklift requires installing eyebolts (provided) and then connecting lifting strap with hardware to the eyebolts (lifting straps and hardware not provided). To use a forklift with eye bolts and lifting straps with hardware, continue in Step 9 to remove the hood and properly install eye bolts.



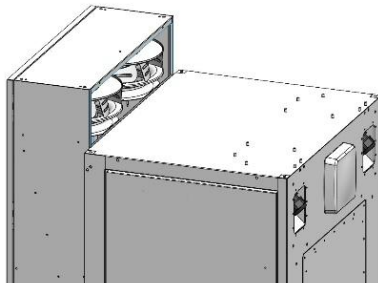
*Figure 15 – Forklift forks may be inserted into either the two open front panels or 2 lifting straps connected to eye bolts on top of charger*

9. If you need to install eye bolts, remove charger's hood and install eye bolts as follows:
- Using a screwdriver with a Torx bit, remove the 3 screws and 3 rubber washers that secure the top of the hood to the top of the cooler.
  - Using a screwdriver with a Torx bit, remove the 2 upper-left and 2 upper-right screws that secure the sides of the hood to the charger (Figure 16), then set the hood and screws aside.

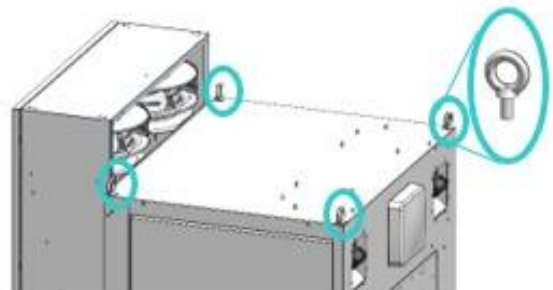


**Figure 16 - Three screws and rubber washers on top of hood and four screws on upper-left and upper-right of hood secure hood to charger**

- Lift the hood off the charger (Figure 17) and set hood and screws aside.



**Figure 17 – Hood removed**



**Figure 18 – Installing eye bolts**

- Fully install the 4 eye bolts provided into the pre-drilled holes in the top of charger.



Note: When fully installed, none of the threads on the eyebolts will be above the roofline (Figure 18).

- Using moving partners and a forklift with either the front-to-back bottom forklift openings or lifting straps connected to eye bolts on the top of the charger, move the charger to the prepared concrete location:



**CAUTION! If using front-to-back bottom openings:** When inserting forklift forks into the bottom openings of the charger, only insert forks into the 2 open front panels, and then only after opening both the front and back panels.

**CAUTION! If using eye bolts and lifting straps:** Eye bolts must be in line with lifting straps (as shown in Figure 17 and Figure 18) so that straps can only pull eye bolts to their left or right.

- Ensure removable plate is still off the right-side floor and out of the charger.
- Safely lift the charger off the pallet and move charger to concrete location pre-marked with charger's outer and inner footprints and with AC power conduit/cable emerging inside inner footprint (Figure 7 and 8).
- If wedge anchors were pre-installed, skip to Step 16 now.

- Lower the charger onto the pre-marked outer footprint on the concrete and over the power-in cable/conduit (like Figure 19, but without wedge anchors pre-installed).

- Using a marker or pencil, reach inside open bottom panels and mark all 8 wedge anchor windows.

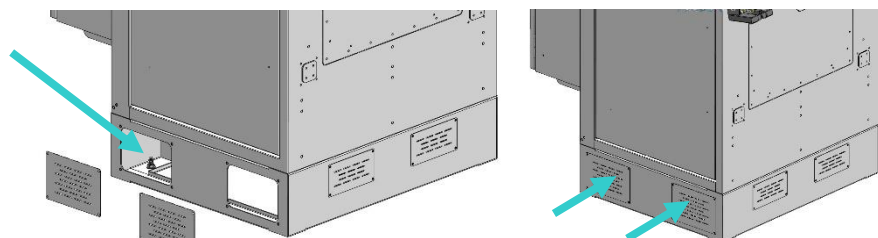
- Safely lift the charger off the prepared location on concrete and temporarily move it aside. The 8 wedge anchor window markings should look like the 8 markings in Figure 9.

- Using a 12 mm (1/2 in.) diameter drill bit, drill 8 holes in the concrete within the 8 wedge anchor window markings.

- Remove washer and nut from wedge anchors and then hammer all 8 wedge anchors 2.25 inches into pre-drilled holes (anchors shown installed in Figure 19).

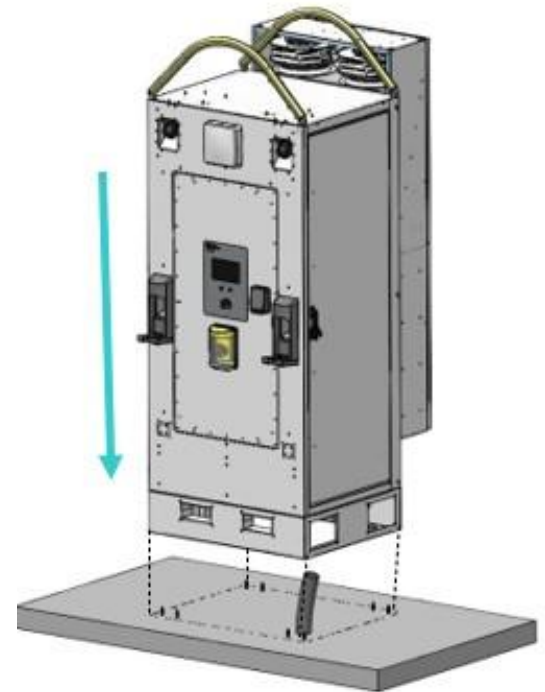
- With washers and nuts still removed from installed wedge anchors, safely lower the charger over the installed wedge anchors and conduit/cable in concrete (Figure 19) so that all 8 anchors feed into their own window.

- Secure charger to concrete using the eight M12 wedge anchors installed and 8 washers and nuts that came with the wedge anchors. Tighten nut down using a torque setting of  $780 \pm 10$  in-lbs ( $90 \pm 10$  N-m) (Figure 20).



**Figure 20 – Tighten washer-nut sets over wedge anchors and then re-attach all lower panel**

- Re-attach all lower access panels to the bottom of the charger using their original screws (Figure 20).



**Figure 19 - Lower Fast Charger onto eight pre-installed wedge anchors**

### 3.5 Install Shelf Controllers, Rectifier Modules, and Inverter Modules



#### ELECTRICAL WARNINGS – WARNING! RISK OF ELECTRIC SHOCK!

**WARNING! RISK OF ELECTRIC SHOCK! ENSURE POWER SUPPLY IS SHUT OFF BEFORE STARTING OR CONTINUING INSTALLATION ACTIVITIES AND BEFORE OPENING EV FAST CHARGER'S TOP PANEL. FAILURE TO OBSERVE THIS PRECAUTION COULD RESULT IN SEVERE INJURY OR DEATH.**

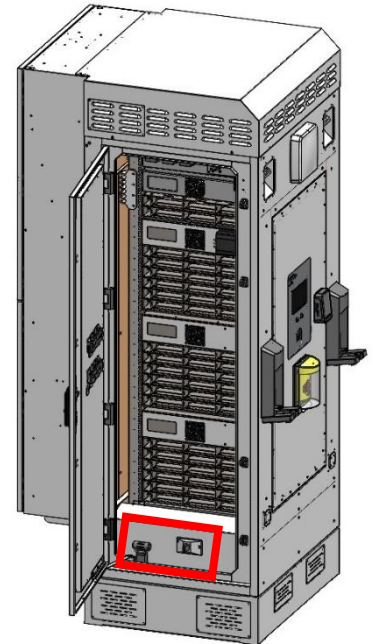
This EV Fast Charger ships with many of its components pre-installed, such as a cellular antenna, CCS1 charging cable, and empty power shelves. Essential charger components that do not ship preinstalled are shelf controllers (SCs), rectifier modules and inverter modules. These can be installed anytime and in any order prior to powering the charger on.



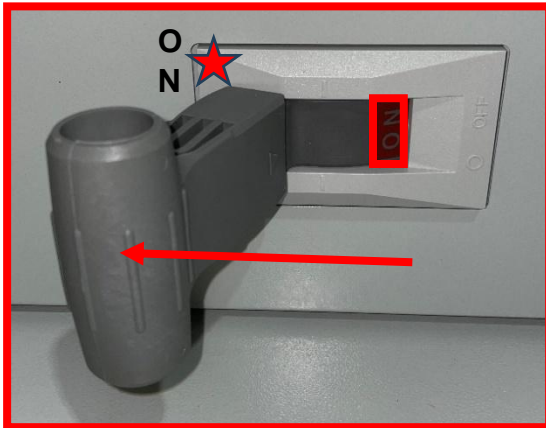
Note: We recommend you first mount the Fast Charger in its permanent location (section 3.4) BEFORE you install the SCs and PSUs. This will greatly lessen the weight of the charger while it is being moved and positioned.

To install shelf controllers and power supply units:

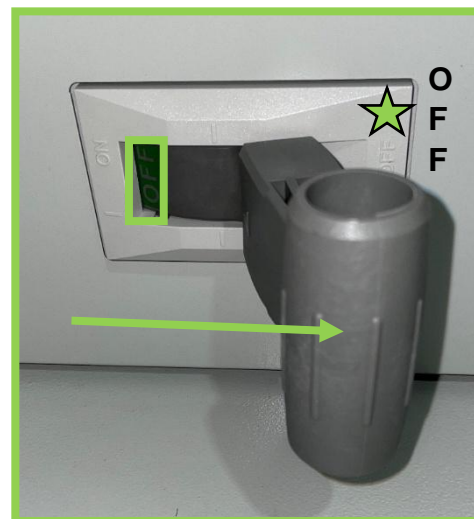
1. Ensure AC power to EV Fast charger is turned OFF at site's upstream AC circuit breaker.
2. Open EV Fast Charger's left-side door.
3. Locate charger's main switch below the empty shelves (Figure 21) and determine if the main switch is in the ON position (Figure 22) or the OFF position (Figure 23).



**Figure 21 – Main Switch and removable handle in a 180 kW EV Fast Charger (inside left-side door)**

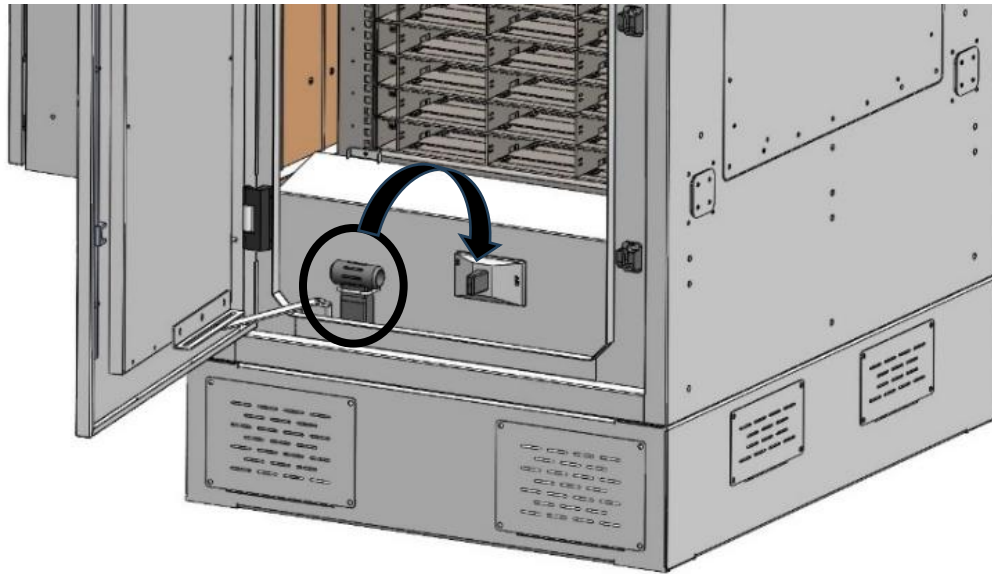


**Figure 22 - Main Switch (shown with handle on) in the ON position**

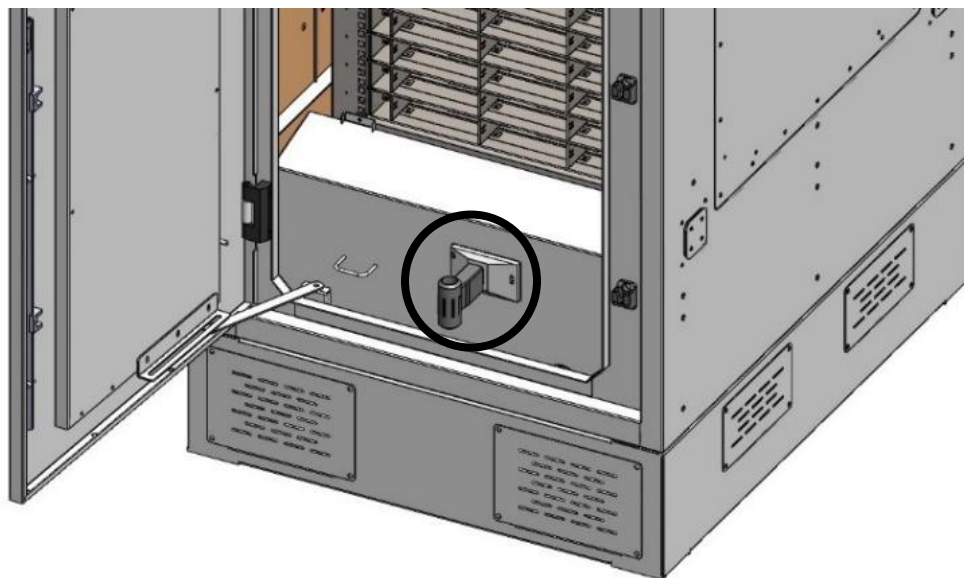


**Figure 23 - Main Switch (shown with handle on) in the OFF position**

4. Ensure Main Switch is in the OFF position (Figure 23) before proceeding with installation.  
If main switch is in the ON position (Figure 22):
  - a. Retrieve main switch handle from its hanger (Figure 24).
  - b. Slide handle onto main switch switch (Figure 25).
  - c. Switch main switch to OFF position.
  - d. Return main switch handle to its hanger.

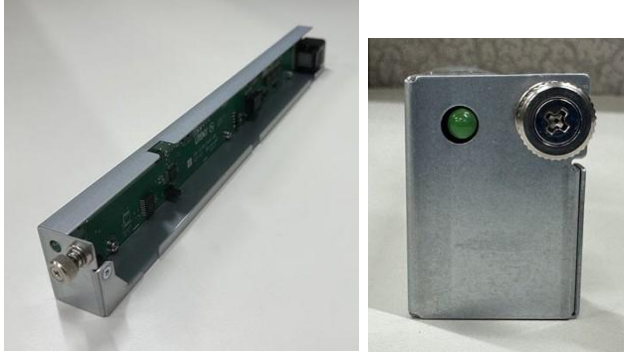


**Figure 24 – Main Switch Handle in handle hanger**

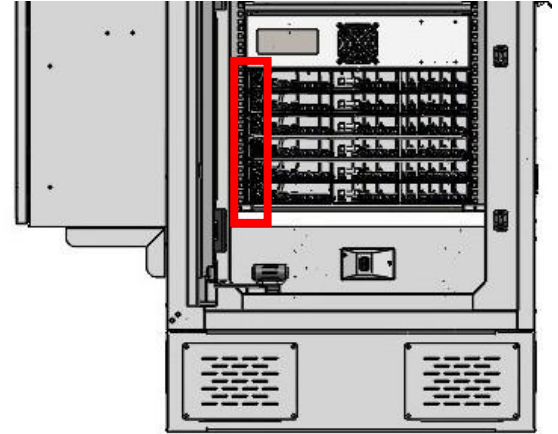


**Figure 25 – Main Switch Handle slid onto the main switch**

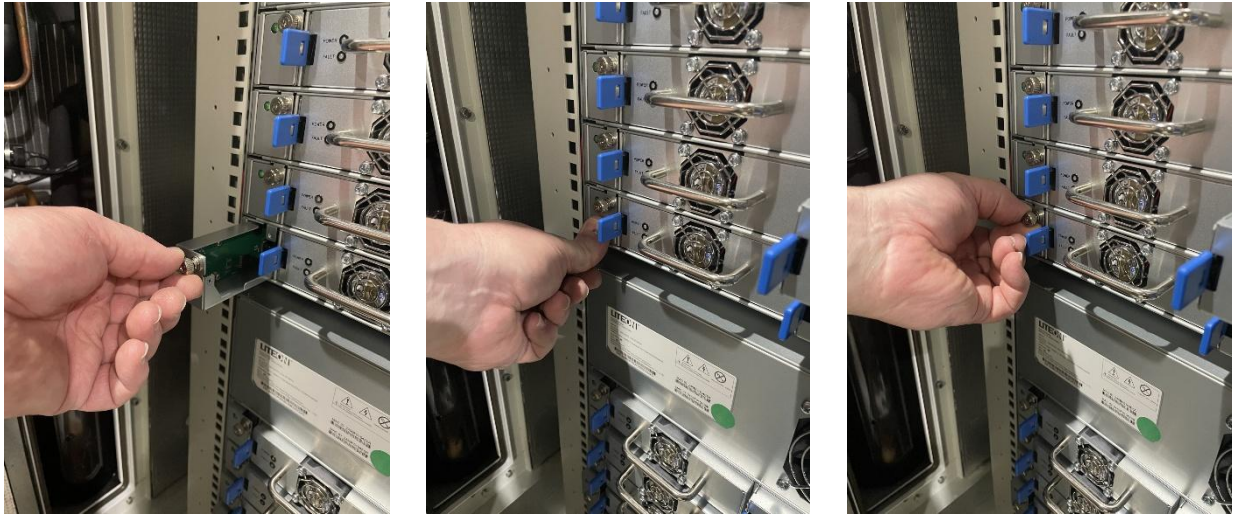
- Also inside the left-side door and starting at the first open slot at the bottom-left of each of the charger's power stacks (Figure 26), insert 1 Shelf Controller (SC) (Figure 27) per shelf and secure it with built-in screw (Figure 28).



**Figure 27 - Shelf Controller**



**Figure 26 – Empty shelves in charger's bottom power stack with six empty shelf controller slots highlighted**

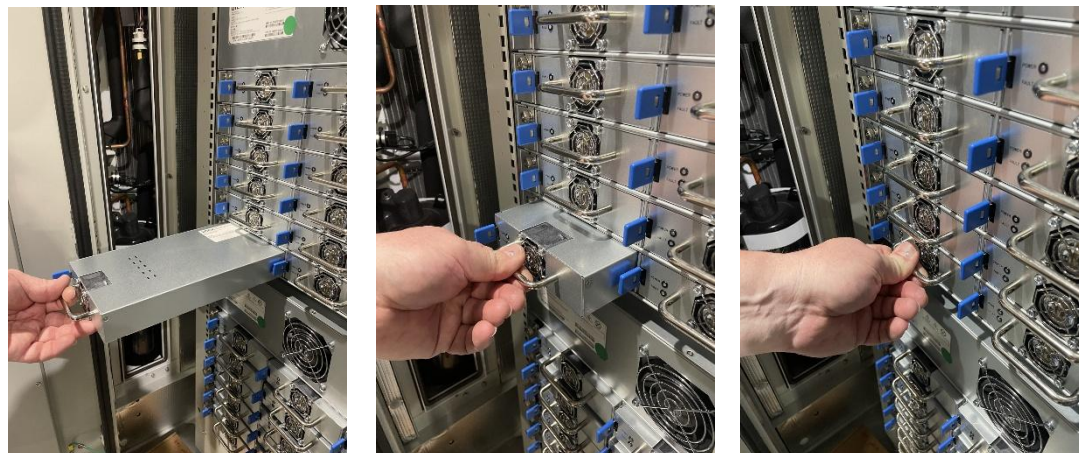


**Figure 28 – Install and Secure Shelf Controllers**

- Insert 3 blue-tabbed Rectifier modules (see Figure 29) into each power stack shelf using the same orientation as Figure 30 (with the locking-tab side of each module closer to its shelf controller than to the module's other side), and so each locking tab clicks into the locked position (pull handle to test the lock).



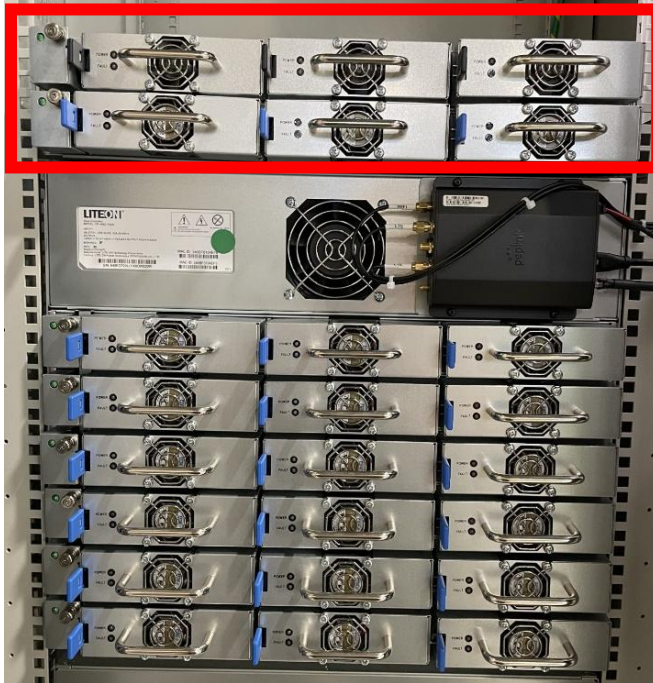
**Figure 29– Rectifier Module**



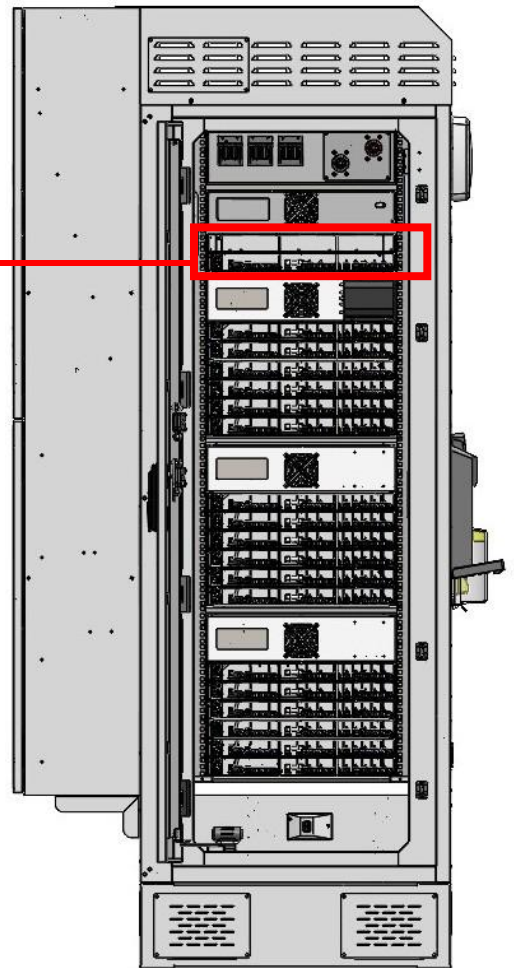
**Figure 30 - Install Rectifier Modules with Locking Tab sides closer to Shelf Controllers**



7. Locate the Inverter Shelf Set in this fast charger (Figure 31), which is located above the highest 6-shelf power stack in each charger (see example in Figure 32). The Inverter Shelf Set powers the Heat Exchanger.

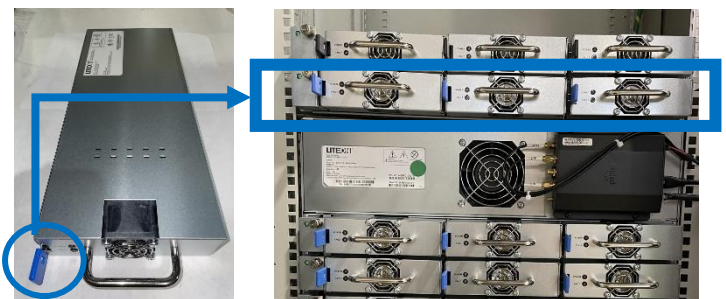


**Figure 31– Inverter Shelf Set has two dedicated shelves:  
Upper Shelf for three (3) Inverter modules (with black tabs)  
Lower Shelf for three (3) Rectifier modules (with blue tabs)**



**Figure 32 – Inverter Shelf Set location in a 180 kW Fast Charger**

8. Insert 3 additional Rectifier Modules (with blue tabs) into the lower shelf of the Inverter Shelf Set (indicated in Figure 33).



**Figure 33 – Rectifier modules (blue tabs) installed in lower shelf of Inverter Shelf Set**

9. Insert the 3 Inverter Modules (with black tabs) into the upper shelf of the Inverter Shelf Set (indicated in Figure 34).

10. Close the left-side door.



**Figure 34 – Inverter modules (black tabs) installed in upper shelf of Inverter Shelf Set** | 21

### 3.6 Configure Cellular Modem and Registering Charger on Network



**WARNING! RISK OF ELECTRIC SHOCK!**  
DO NOT CONNECT AC POWER SUPPLY TO EV FAST CHARGER UNTIL PHYSICAL SIM CARDS ARE INSERTED INTO CELLULAR MODEM AND TOP PANEL COVER AND SCREWS ARE REINSTALLED.



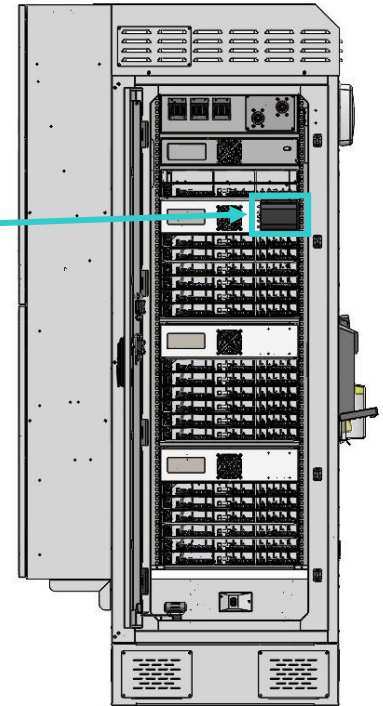
Note: Physical SIM cards for cellular modem must be provided by product owner or administrator.

To configure cellular modem with physical SIM card and register the charger on the backend network:

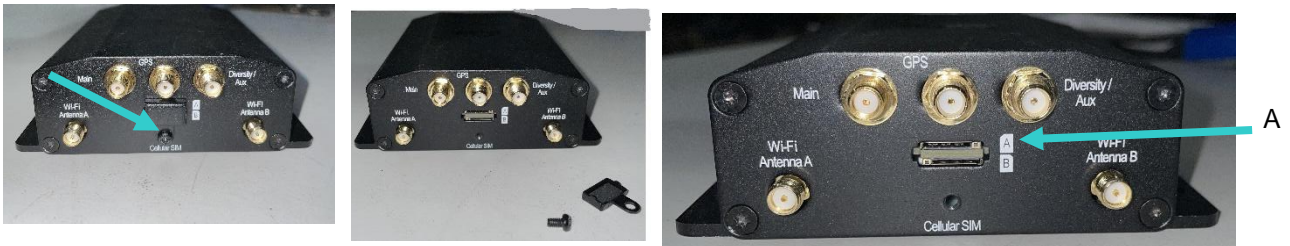
1. Ensure AC power to EV Fast charger is turned OFF at site's upstream AC breaker.
2. Open EV Fast charger's left-side door and locate the pre-installed modem (Figure 35).



**Figure 35 - Locating pre-installed cellular modem inside left-side door**



3. Remove the screw from the face of cellular modem as indicated in Figures 36 and then remove slot cover to expose modem's expansion slots.



**Figure 36 - Removing screw and small slot cover to expose SIM card slots A and B**

4. Insert a physical SIM card in slot A only.
5. Return slot cover to its original position on modem and secure it with original screw.
6. Close the left-side door.
7. Register this EV charger as one of the supported devices on the owner's backend network.

Later, after you have configured and wired the AC power input and applied power to the charger, the modem will find the cellular network and attempt to automatically connect.

### 3.7 Configure and Wire AC Input Power



**ELECTRICAL WARNINGS – WARNING! RISK OF ELECTRIC SHOCK!**

**WARNING! RISK OF ELECTRIC SHOCK!**

**SHUT OFF POWER SUPPLY BEFORE BEGINNING INSTALLATION ACTIVITIES. FAILURE TO OBSERVE THIS PRECAUTION COULD RESULT IN SEVERE INJURY OR DEATH.**

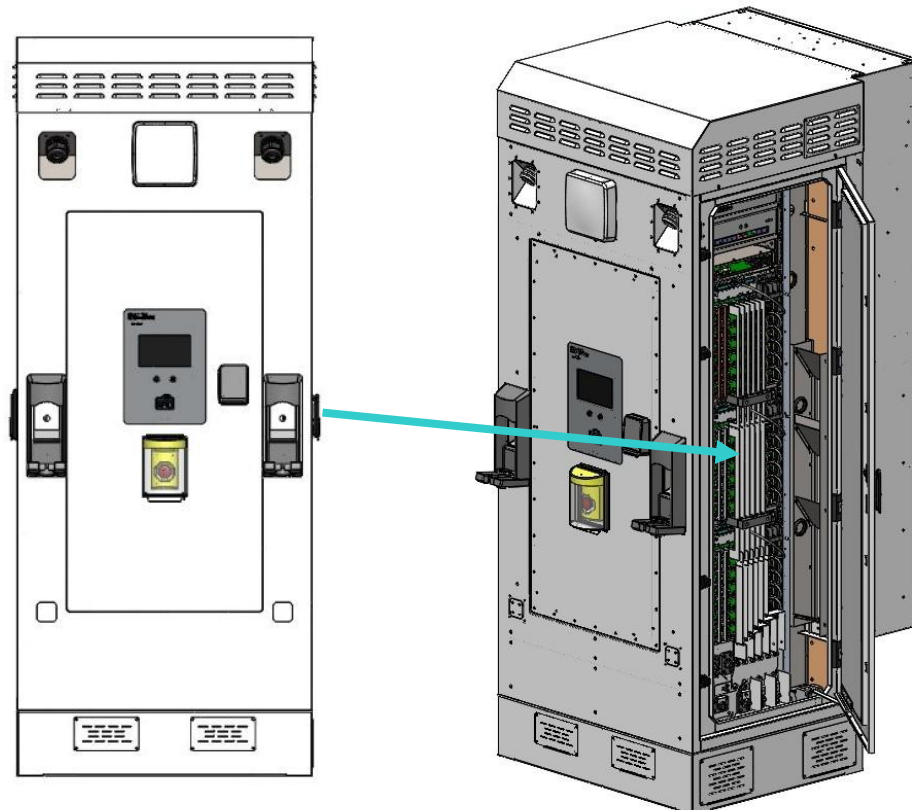
**WARNING! RISK OF ELECTRIC SHOCK!**

**DO NOT PROVIDE LIVE POWER TO THE EV FAST CHARGER UNTIL BUS BAR CONFIGURATION AND AC WIRING IS COMPLETE AND THE AC SERVICE PANEL IS IN PLACE AND SECURE.**

**WARNING! RISK OF ELECTRIC SHOCK!**

**ONLY QUALIFIED ELECTRICAL PERSONNEL FAMILIAR WITH THE CONSTRUCTION AND OPERATION OF THIS TYPE OF EQUIPMENT AND THE HAZARDS INVOLVED SHOULD ADJUST, MODIFY, AND SERVICE THIS EQUIPMENT. FAILURE TO OBSERVE THIS PRECAUTION COULD RESULT IN SEVERE INJURY OR DEATH.**

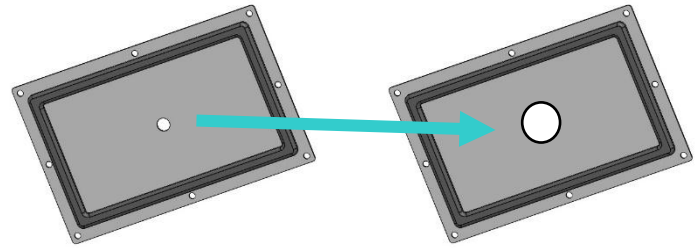
1. Ensure AC power to EV Fast charger is turned OFF at site's upstream AC breaker.
2. Open the right-side door of charger (see Figure 37).



**Figure 37 - Opening EV Fast Charger's right-side door**

3. Determine the size of opening needed in the Removeable Plate (based on the size of conduit coming into charger through the opening behind the right-side door).

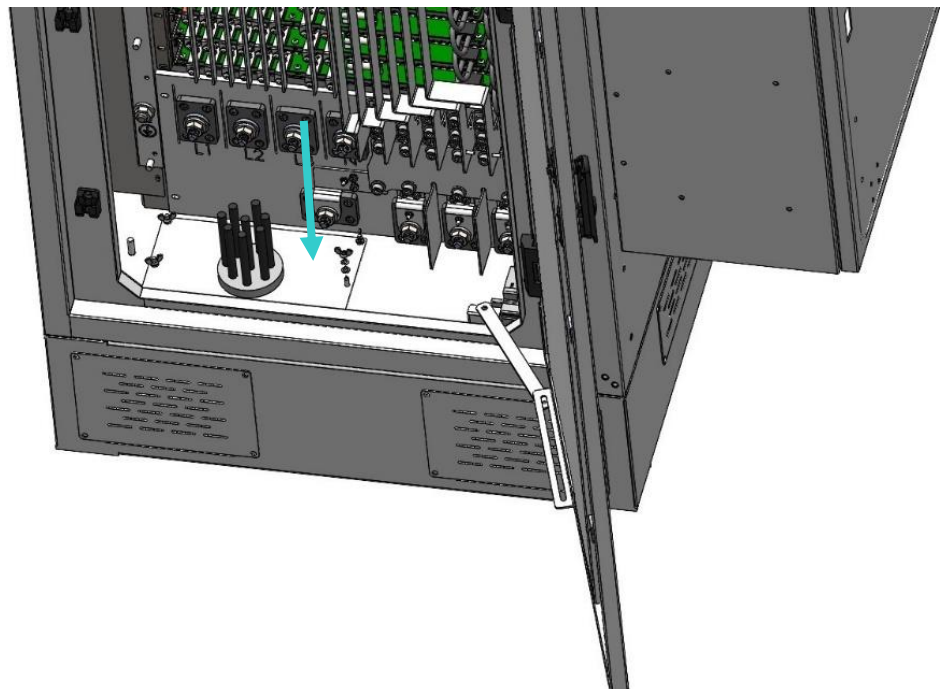
4. Using a drill, enlarge pilot hole in removeable plate outside of and away from the charger. Ensure new hole is large enough to feed AC power-in conduit and wires through (see Figure 38).



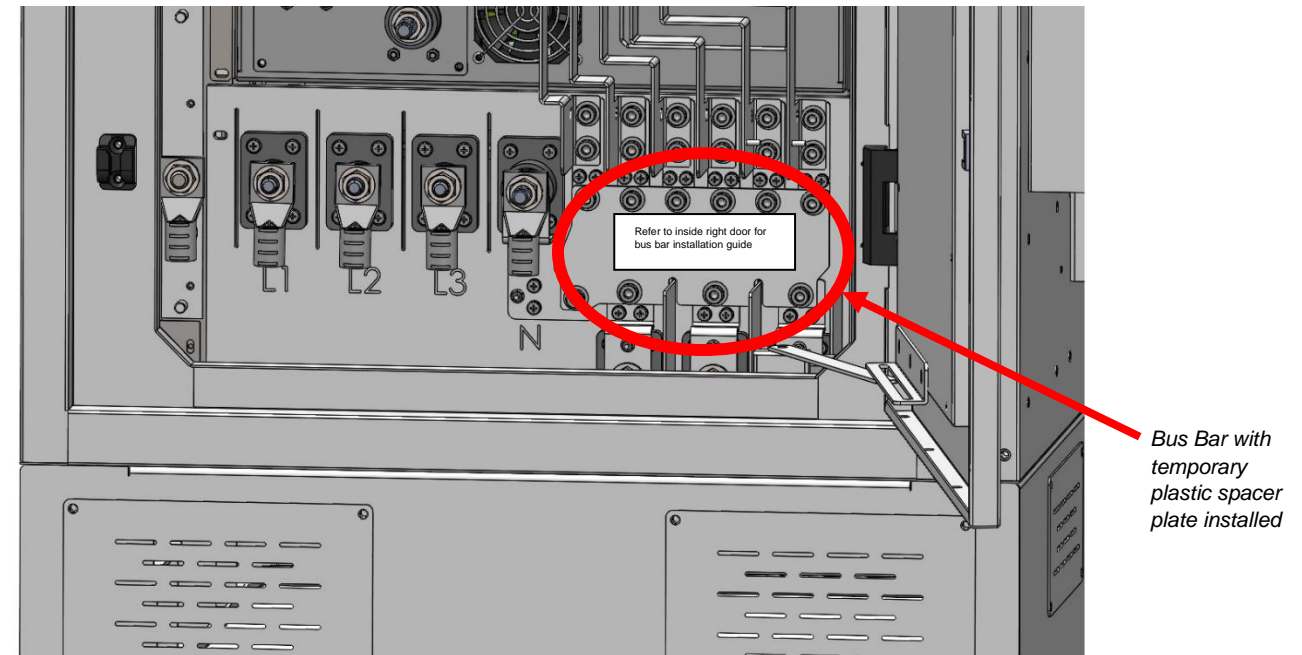
**Figure 38- Enlarge pilot hole in removable plate to fit over conduit used for AC Input wires**

5. Inside the right-side door of the charger, slide the removeable plate (gasket-side down) over the AC power-in conduit/cable (Figure 39), taking care not to damage the gasket, and then lower the plate back onto the 8 small studs. We recommend using a cable gland (installer supplied), sized appropriately for the cable being fed through plate to complete this step OR using duct seal after re-securing plate to the charger in step 7.
6. Return the 8 sets of M5 wingnut, split washer, and flat washer to studs and hand-tighten to secure plate to charger (also Figure 39).
7. (Recommended) If you didn't use a cable gland in step 5, use Duct Seal now around conduit or cable being fed through the removable plate.

**Figure 39 - Placement of Removeable Plate inside bottom of charger (optional Cable Gland not shown)**

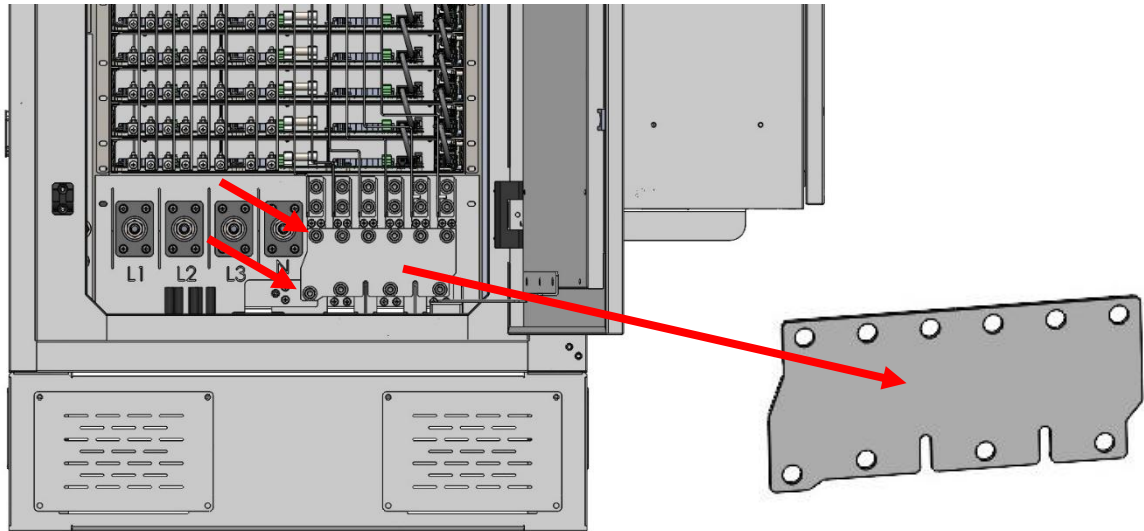


8. Locate Bus Bar near bottom right-side. A temporary plastic spacer plate is installed, as shown in Figure 40, your charger's bus bar needs to be configured: **Continue to the next step** to begin configuring the bus bar.



**Figure 40 - Bus Bar with temporary plastic spacer plate installed**

- Remove the six M6 and four M8 socket head cap screws that secure plastic spacer plate to Bus Bar (Figure 41), remove spacer plate from Bus Bar, and discard spacer plate.

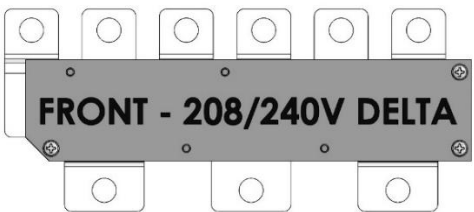
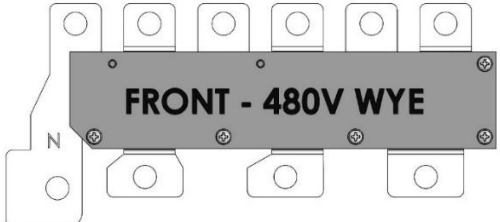




**Figure 41 - M6 and M8 socket head cap screws must be removed to remove plastic spacer plate**

- Determine which of the two supported AC Input Power configurations is required for this installation (see Figure 42).

**208V/240V 3-phase Delta (3-wire + PE):** Line 1, Line 2, Line 3, Ground

**480V 3-phase WYE (3-wire + Neutral + PE):** Line 1, Line 2, Line 3, Neutral, Ground

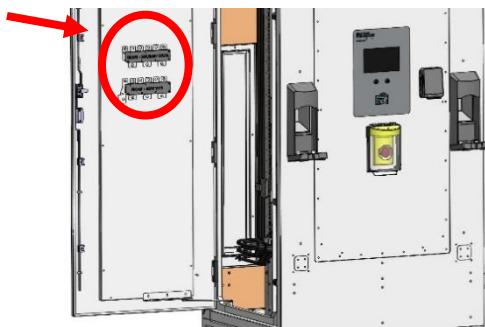
208/240 V 3-phase Delta (3-wire + PE)	480 V 3-phase WYE (3-wire + Neutral + PE)
 <p><b>FRONT - 208/240V DELTA</b></p>	 <p><b>FRONT - 480V WYE</b></p>
 <p><b>CAUTION!</b> Do not use this Delta configuration bus bar for a 480V 3-phase Wye (3-wire + Neutral + PE) source, which requires a neutral.</p>	 <p><b>CAUTION!</b> This source requires the Neutral line to be supplied and connected to prevent damage to equipment.</p>

**Figure 42 - Configuration Bus Bar to install for each supported AC Input Power Configuration**



**CAUTION!** Configuration Bus Bar must be loaded on and anchored to Bus Bar with the “FRONT” etching or stamp facing out, as shown in Figures 35 and 38.

11. The two configuration bus bars/plates shown in Figure 42 are included with your charger and ship in their storage position anchored inside the left door (see Figure 43). Select the configuration bus bar required for your site's AC Input Power Configuration and unscrew it from the door.

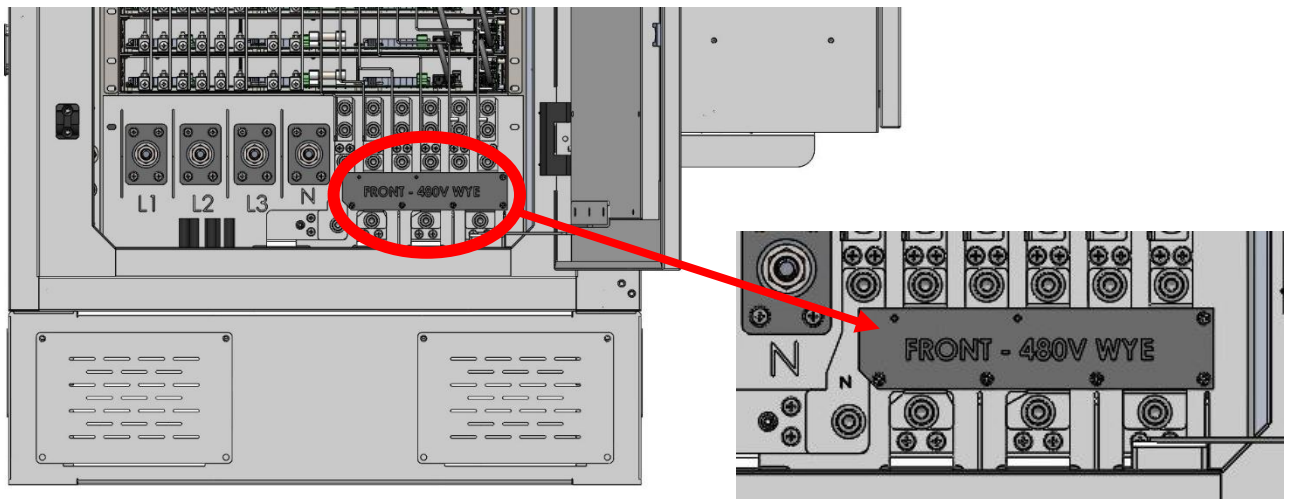


**Figure 43 - Inside left door is shipping/storage location of 2 configuration bus bars**

12. Install the configuration bus bar/plate required for this charger's AC input power as follows:
  - a. Place selected configuration bus bar/plate on the bus bar with its "FRONT" etching or stamp facing out (such as the "FRONT – 480V WYE" example shown in Figure 44).
  - b. Secure 6 upper socket head cap screws, hand tight only and not over 177 in-lbs (48 N-m).
  - c. Secure 4 lower socket head cap screws, hand tight only and not over 424 in-lbs (20 N-m).



**CAUTION! Configuration Bus Bar must be loaded and secured on Bus Bar with the "FRONT" etching or stamp facing out, as shown in Figure 44.**



**Figure 44 - FRONT – 480V WYE Configuration shown secured on Bus Bar**

13. Notice the two AC input power wiring configurations shown in Figure 45, then select the wiring configuration and the ring terminals or Chair/Box lugs needed for this charger's AC power configuration.

- **Earth Ground (PE):**  
Ring Terminal for Earth Ground must fit 1/2 in.(M8) diameter stud (Figure 45).
- **Neutral Wire:**  
Ring terminals for Neutral wires must fit 1/2 in. diameter Junction Block stud (see Figure 45).
- **Line Wires:**  
Option A - Ring terminals for Line wires must fit 1/2 in. diameter Junction Block stud (see Figure 45) or  
Option B - Chair/Box Lugs with Spacers may need to use three Aluminum Chair/Box lugs (not included) with three copper extensions (included - see Figure 46).



**Note:** When prompted in the next step, the nuts provided to secure the ring terminals or the copper extensions to their studs should be tightened to 34-39 N-m (300-345 in-lbs.) Likewise, the bolts securing Chair/Box lugs to the copper extensions should also be tightened to 34-39 N-m.

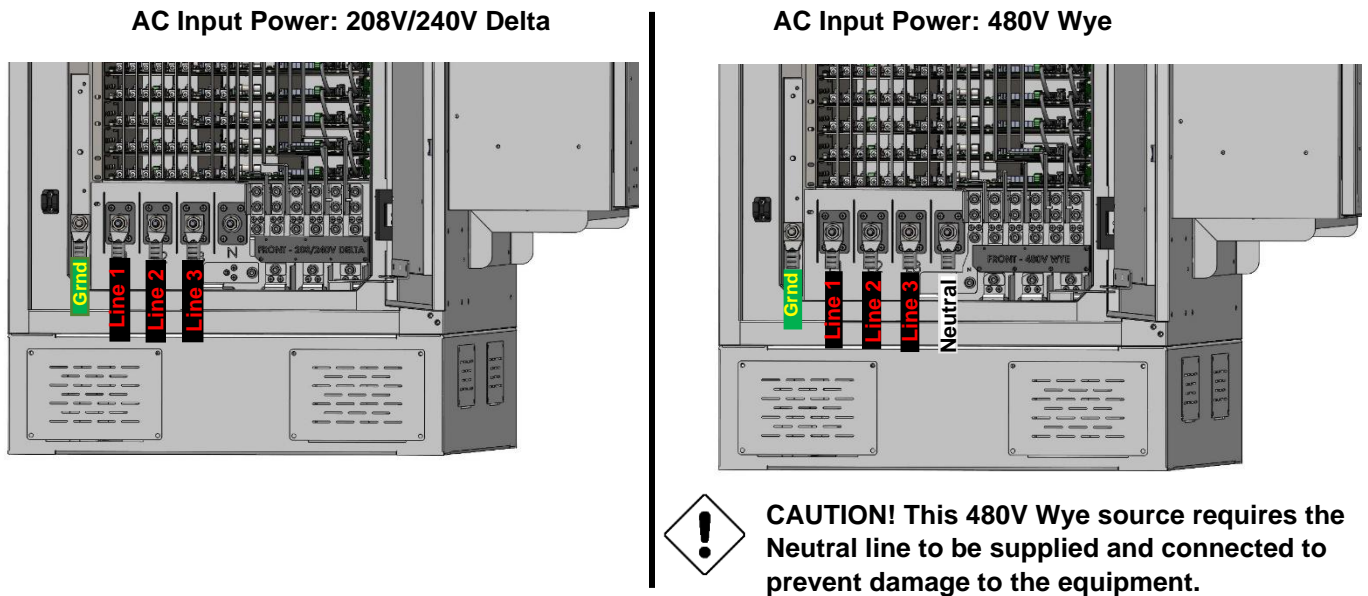


Figure 45 - AC Input Wiring for different AC Input Power Configurations

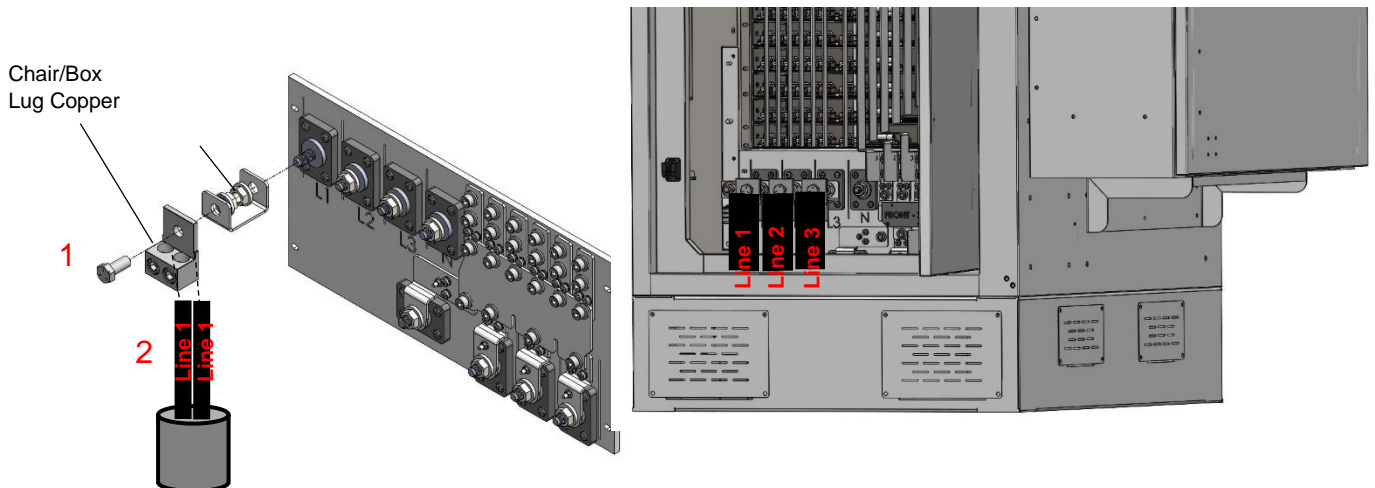


Figure 46 - (1) Chair/Box Lugs (not provided) with Copper Extensions (provided) can be used in place of Ring Terminals (2) when wiring AC input Lines 1, 2, or 3



14. Wire AC Input Power to charger's AC Main Switch connectors using properly-sized ring terminals or Chair/Box lugs (not provided) with nut-washer sets and copper extensions (provided):
  - a. If using ring terminals (Figure 45), secure each wired ring terminal to the stud required using the washer and nut provided, then tightened the nut to 34-39 N-m (300-345 in-lbs.).
  - b. If using Chair/Box lugs with copper extensions (Figure 46):
    - i. Secure each copper extension to the stud required using the washer and nut provided, then tightened the nut to 34-39 N-m (300-345 in-lbs.).
    - ii. Secure each Chair/Box lug to a copper extension using Chair/Box lug-specific bolt and hardware (not provided), then tightened the bolt to 34-39 N-m (300-345 in-lbs.).
    - iii. Install AC Input Power wires required into appropriate Chair/Box lugs and secure.

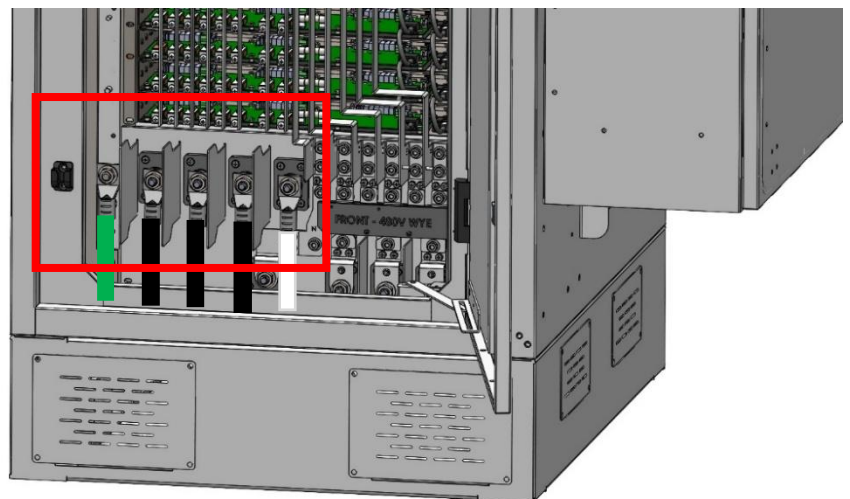
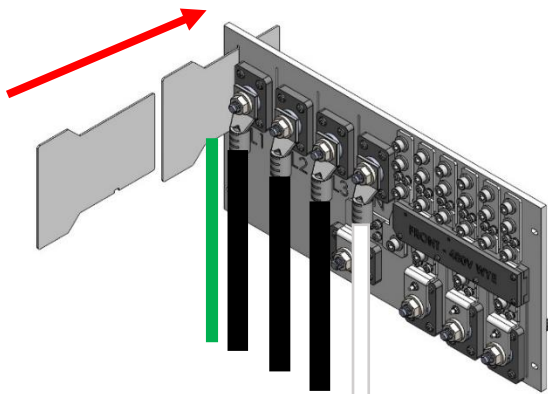


**CAUTION!** Ring terminals or chair/box lugs should maintain suitable spacings. The ring lugs or chair/box lugs should be vertical when tightened.

**Reminder:** The installer is responsible for conforming to all local and national electrical codes and standards applicable in the jurisdiction this equipment is installed in.

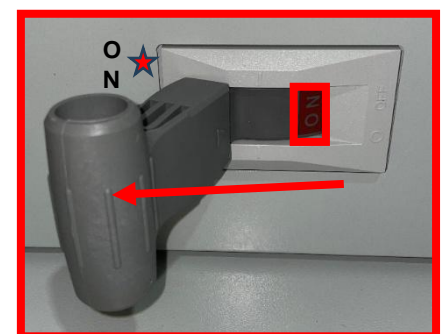
15. After all input power wires have been secured to AC Main Switch studs, insert and seat the four plastic phase barriers provided (Figure 47) in between the AC Input Power wiring.

16. Using Silicon caulk, secure each phase barrier in place with a small bead of caulk on each side of each barrier.



**Figure 47 - AC Input Wiring for different AC Input Power Configurations**

17. Close the right-side door.
18. At site's AC circuit breaker, turn on breaker and check voltage input. If voltage input is not OK, turn OFF AC circuit breaker and troubleshoot the issue. If voltage input is OK, open left-side door of charger and move charger's Main Switch to the ON position (Figure 48).
19. Close left-side door. This EV Fast Charger is now ready for use.



**Figure 48 – Main Switch in the ON position**

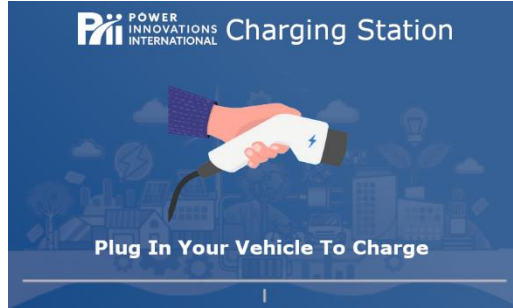
## 4—Operating EV Fast Charger

---

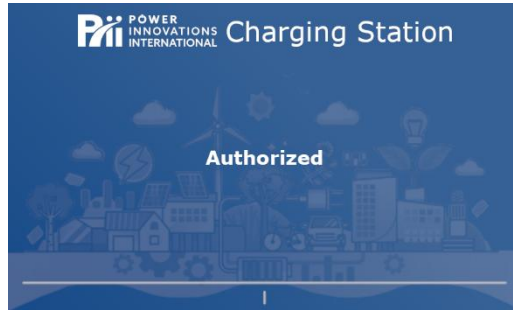
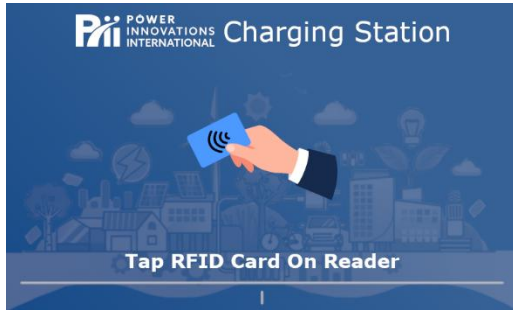
### 4.1 Charge an EV using a Single-cable EV Fast Charger Model

To charge an electric vehicle (EV) with a Single-cable EV Charger model:

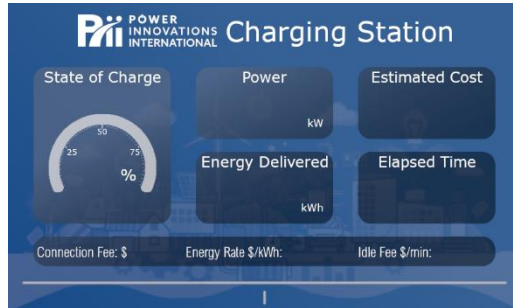
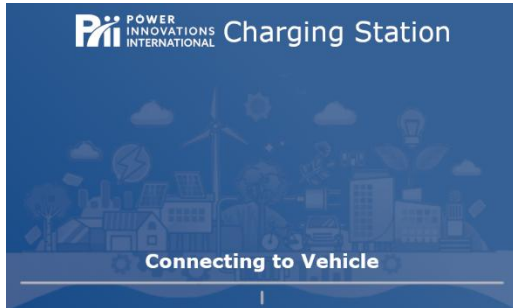
1. Lift EV cable plug from holster and plug into EV.



2. Tap ID card on RF card reader and wait for authorization.



3. Follow on-screen displays to verify charger connects to vehicle and begins charging cycle.

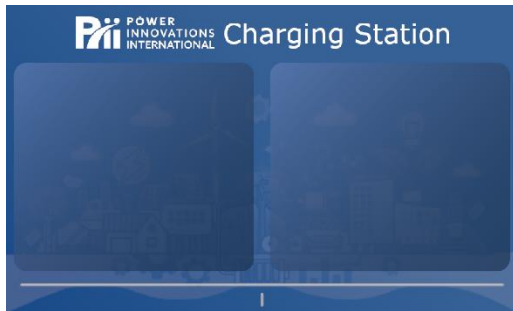


Throughout the charging cycle, the progress of the charge displays.

## 4.2 Charge an EV using a Dual-cable EV Fast Charger Model

To charge an electric vehicle (EV) with a Dual-cable EV Charger model:

1. Lift Left or Right EV cable plug from holster and plug into EV.



2. Choose a Payment method for your charging cable you are using (Left or Right), tap or swipe to pay, and then wait for authorization.



3. Follow on-screen displays to verify charger connects to vehicle and begins charging cycle. Throughout the charging cycle, the progress of the charge displays on your cable's side of the screen (Left or Right).
4. To end a charging session, see next section.



### 4.3 End a Charging Session

1. To end the charging cycle early (before a full charge is complete), simply unplug (disconnect) the CCS1 handle/plug from the vehicle.



Note: Emergency Stop is not intended to be pressed to stop a normal charging session. It is intended for use in case of an emergency.

In case of emergency, if unplugging handle safely is not possible, use Emergency Power Off button: Lift cover over the Emergency Power Off button, press the button, and follow the on-screen prompts.

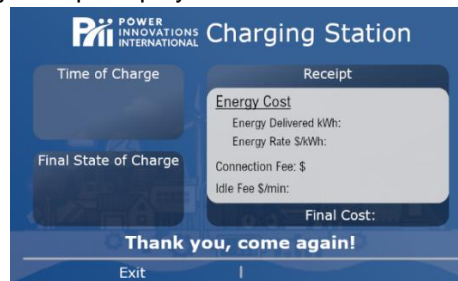


**Figure 49 – Pressing Emergency Power Off button is only for Emergencies. DO NOT press to stop a normal charging session.**

2. At the end of the charging cycle (when EV Battery is fully charged or if charging cycle was ended early), the following prompt displays. Return the charging cable to its dock/plug holster. Once charging cable is disengaged from EV and placed in its dock/plug holster, an on-screen summary/receipt displays.



When Cable is unplugged from EV

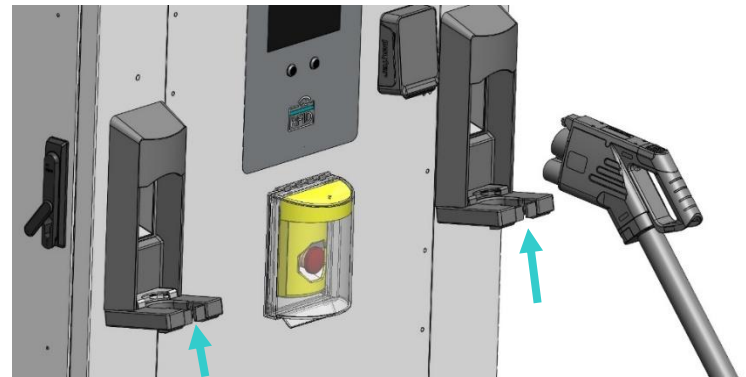


Final Screen on Single Cable Charger

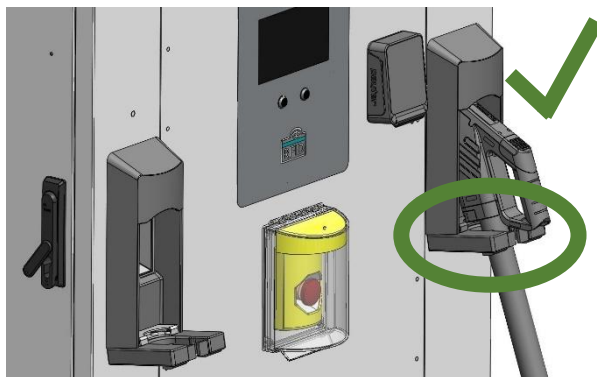


Final Screen on Dual Cable Charger

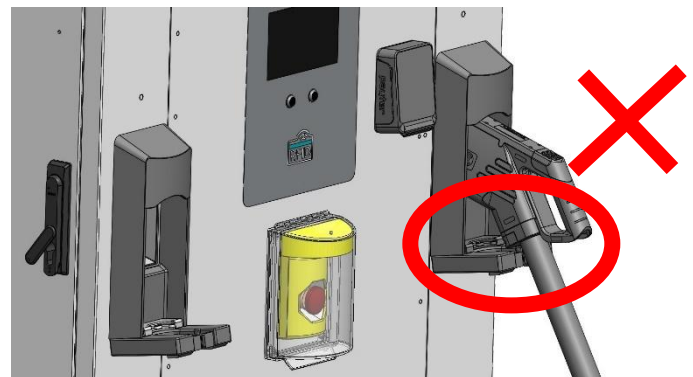
3. Ensure charging cable is seated correctly in its dock/plug holster: Whenever the charging cable plug is being returned to the holster, tilt the handle back to angle the plug up as you lift the handle and press it into the holster. The cable below the handle should clear (or be behind) the holster's rubber gate (Figure 50-52).



**Figure 50 - Charging Cable holsters have a rubber gate that helps ensure properly seated handle**



**Figure 51 - Charging Cable handle docked correctly with cable behind holster's rubber gate**



**Figure 52 - Charging Cable handle not docked correctly (cable still outside holster's rubber gate)**

## 5—Maintaining EV Fast Charger



**ELECTRICAL WARNING: SHUT OFF POWER SUPPLY AT AC BREAKER BEFORE BEGINNING INSTALLATION ACTIVITIES AND BEFORE REMOVING EV FAST CHARGER'S AC SERVICE PANEL FOR ANY MAINTENANCE WORK. FAILURE TO OBSERVE THIS PRECAUTION COULD RESULT IN SEVERE INJURY OR DEATH.**



**CAUTION!** Maintenance tasks should only be completed annually or as needed and as directed in this section. When in doubt, contact Power Innovations on how to proceed.

### 5.1 Restart after Emergency Power Off

Pressing the Emergency Power Off button will stop the current charging cycle or session. Every time the Emergency Power Off button is pressed, it stays recessed until it is reset to prepare for the next charging session.

To reset Emergency Power Off button:

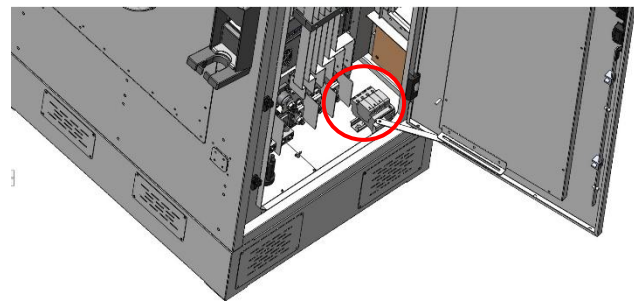
1. Lift Emergency Power Off button cover and rotate the button clockwise (Figure 53) to unlock it and pop it out.
2. Close button cover.



*Figure 53 - Reset Emergency Power Off button*

### 5.2 Replace Surge Modules in Surge Protective Device

This EV Fast Charger is equipped with a Surge Protective Device (SPD), located on the floor of the charger behind the right-side door (see Figure 54).



*Figure 54 - Surge Protective Device that contains replaceable surge modules*

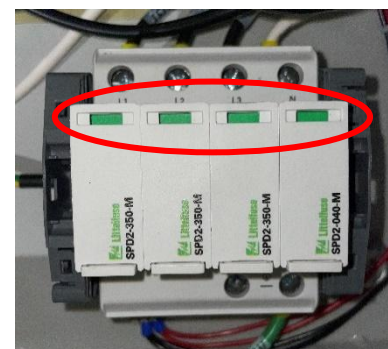
The SPD contains four replaceable Surge Modules. A window in each module indicates its status by color (see Figure 55):

- Green = OK
- Red = Replace

If surge modules need to be replaced, the replacement modules should have:

- Same manufacturer as charger's original SPD
- Same MCOV value as charger's original SPD and modules

If you need assistance in ascertaining SPD manufacturer, MCOV value, or surge module replacement process, contact Power Innovations.



*Figure 55 - SPD with four green modules*

## 6—Regulatory

---

### UL & CSA

This product and its documentation comply with the following UL Standards:

- UL 2202 Standard for Safety: Electric Vehicle (EV) Charging System Equipment
- UL 2231-1 Standard for Safety: Personnel Protection Systems for Electric Vehicle (EV) Supply Circuits; Part 1: General Requirements
- CSA C22.2 346 (Canadian Standards Association) – DC Charging Equipment for Electric Vehicles
- CSA C22.2 281.1 – Personnel Protection Systems for Electric Vehicle Supply Circuits

## 7—Warranty

---

Power Innovations International warrants that products purchased hereunder are free and clear of all liens and encumbrances.

Power Innovations International warrants that products are to be free from material or workmanship defect under normal use for a period of two (2) years from the invoice date.

In the event that any defect is found under normal usage conditions during the above warranty period, Power Innovations International will be responsible for repair or replacement at its sole discretion and subject to the replacement may be refurbished products.

All repair covered by this warranty must be done at Power Innovations International factory, or other repair facilities as designated by Power Innovations International unless Power Innovations International specifically directs that this service be performed at another location or service provider.

Customer shall, at its own costs, be responsible for shipping the defective products to the designated repair facilities subject to a RMA issued by Power Innovations International.

Power Innovations International will be responsible for shipping the repaired or refurbished unit back to the customer.

Power Innovations International shall not have any warranty obligations for claims: (i) caused by the misuse or abuse of products by end users; (ii) caused by modifications or repairs made to the products or disassembly of products by any person other than Power Innovations International, unless receiving Power Innovations International authorization; (iii) in relation to the appearance damage.

This Warranty Term states the exclusive liability of Power Innovations International and the exclusive remedy of buyer/customer with respect to any claim or defects of the products.

## 8—Contact Information

---

If there are any questions or comments about this product, please feel free to contact us.

**Power Innovations International, Inc.**

**Web:** [www.powerinnovations.com/support](http://www.powerinnovations.com/support)

**Phone:** 801-785-4123

**Mailing Address:** 1305 South 630 East, American Fork, UT 84003

**Copyright © 2024-2025**

Power Innovations International, Inc. American Fork, UT, USA

*All rights reserved*